

# WHAT'S NEW

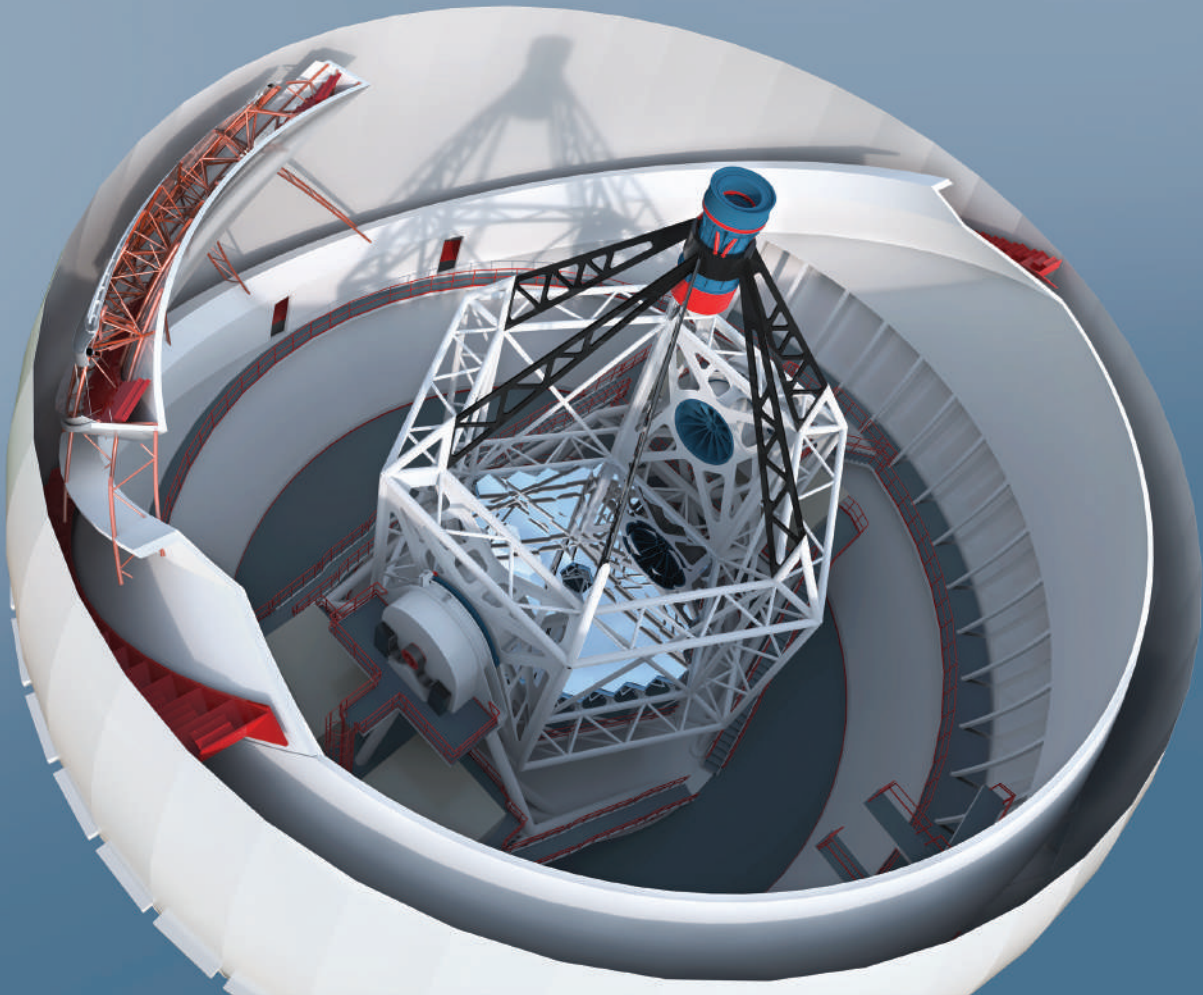





## SOLIDWORKS 2019







# Contents



---







- Legal Notices ..... 11
  
- 1 Welcome to SOLIDWORKS 2019 ..... 14**
  - Top Enhancements ..... 15
  - Performance Improvements ..... 16
  - For More Information ..... 20
  
- 2 User Interface ..... 22**
  - Breadcrumbs Enhancements ..... 22
  - Customizing Task Pane Tabs ..... 22
  - Improved Preview for Minimized Documents ..... 23
  - Keyboard Accessibility ..... 23
  - Markups for Collaboration ..... 24
  - Measure Tool ..... 24
  - Microsoft Surface Dial in SOLIDWORKS ..... 24
  - Open Dialog Box ..... 25
  - Opening Part Configurations in Quick View Mode ..... 25
  - Recent Documents Improvements ..... 26
  - Rollback Bar Drag Interaction ..... 27
  - Status Feedback ..... 27
  - Touch Mode ..... 27
  
- 3 SOLIDWORKS Fundamentals ..... 28**
  - Application Programming Interface ..... 28
  - Changes to System Options and Document Properties ..... 29
  - Specifying a Default Save Folder ..... 32
  
- 4 Installation ..... 33**
  - Faster Download ..... 33
  
- 5 Administration ..... 34**
  - Admin Portal ..... 34
    - Assign Members to a Product ..... 34
    - Filter Products and Services ..... 34
  - Comparing Geometry in the Upgrade Assistant ..... 35
  - Improved Performance with Pack and Go ..... 35
  - Improved Problem Capture in SOLIDWORKS Rx ..... 35
  - Language Translation for Settings Administrator Tool ..... 36







<b>6 Assemblies</b> .....	<b>37</b>
Bounding Box in Assemblies 	37
Bounding Box PropertyManager.....	38
Component Preview Window .....	39
Cosmetic Threads.....	40
Defeature PropertyManager - Silhouette 	40
Defeature - Define Groups.....	40
Exploded Views 	43
External References 	43
Large Design Review.....	47
Editing Assemblies in Large Design Review.....	47
Large Design Review Mark.....	49
Limitations for Tools in Edit Assembly Mode.....	49
Magnetic Mates in Large Design Review.....	50
Lightweight Mode.....	50
Mates.....	51
Automatically Lock Rotation for Concentric Mates to Toolbox Components.....	51
Disabling Automatic Mate Updates in Toolbox .....	51
Grouping Mates and Separating Fasteners.....	52
Negative Values for LimitAngle Mates in Mate Controller.....	53
Patterns.....	54
Circular Patterns.....	54
Including Custom Properties in a Mirrored Assembly.....	55
Linear Patterns.....	55
Performance Evaluation.....	56
Saving an Assembly as a Part 	57
Assemblies Saved as Parts Export Options.....	57
Save Assembly as Part PropertyManager.....	58
Select Identical Components.....	59
Treehouse.....	61
Create Custom and Configuration-specific Properties in Treehouse 	61
Display in a List View .....	62
Select Multiple Files for Import.....	62
Treehouse Graphics Area Enhancements .....	63
Treehouse Options 	63
Warning When Inserting Complex Components.....	65
<b>7 SOLIDWORKS CAM</b> .....	<b>66</b>
Assign Default Strategies to Machine Types.....	66
CNC Compensation for Curve Features.....	66
Corner Slowdown and Arc Feed Rate.....	66
Improved Chamfer Machining .....	66

Improved Toolpath Editing.....	67
Improvements to Tolerance-based Machining.....	67
More Parameters for Tapered Shanks and Support for Barrel Tool Type.....	67
<b>8 CircuitWorks.....</b>	<b>68</b>
Recognizing Additional SOLIDWORKS Features in CircuitWorks.....	68
<b>9 SOLIDWORKS Composer.....</b>	<b>69</b>
SOLIDWORKS Composer.....	69
Animation Library Workshop and Timeline Enhancements.....	69
Defining Custom Import Profiles.....	70
Importing Assembly Envelopes Option.....	70
Importing PMI Data.....	70
Markup Properties.....	71
Measurement Properties.....	71
Number of Selected Actors Appears in the Status Bar.....	72
Search for Collaborative Actors.....	72
Search for Commands in the Ribbon.....	72
Select Adjacent Parts.....	72
SOLIDWORKS PDM Integration.....	72
Undefined Color Properties in Animation Library.....	73
User Experience Enhancements for SOLIDWORKS Composer.....	73
Versioning of Backup Files.....	74
Working with Views.....	74
SOLIDWORKS Composer Sync.....	74
Conversion Properties - Occlusion Options.....	74
Importing Assembly Envelopes Option.....	75
Importing PMI Data.....	75
Remove Empty Groups After Occlusion.....	76
<b>10 DimXpert.....</b>	<b>77</b>
Copying DimXpert Schemes to Derived Parts.....	77
DimXpert Features.....	77
DimXpert for Assemblies.....	77
MBD Dimension.....	77
<b>11 Detailing and Drawings.....</b>	<b>78</b>
Automatic View Updates and Exclusions.....	78
Configuring the Precision of Dimensions and Tolerances.....	79
Displaying Scrollbars.....	80
Drawing Open Progress Indicator  .....	80
ISO Tolerance-Modifying Symbols.....	81
Performance Improvements - Detailing and Drawings.....	84
Removed Section Views.....	85
Tables.....	86











Changing Cell Border Thickness 	86
Custom Properties in Lightweight BOMs	87
Customizing Quantity Column Headers in BOMs	88
Hole Table Tags - Prefixes, Numbers, and Order	89
Including Thumbnails in BOMs Exported to Microsoft Excel	89
<b>12 eDrawings</b>	<b>91</b>
Configurations in SOLIDWORKS Parts 	91
Configurations in SOLIDWORKS Assemblies 	91
eDrawings Performance	91
eDrawings Professional Features 	92
Perspective Views	92
Using Ambient Occlusion	92
Save As Web HTML	92
Supported File Types in eDrawings	93
<b>13 SOLIDWORKS Electrical</b>	<b>95</b>
Black Box Terminals	96
Cable Cores	96
Connector Graphical Representation	96
Conversion to Mixed Scheme Drawing	96
End Terminations	96
Input/Output Symbol	97
Links in Report Drawings	97
Macro Tool	98
Option for Dimension Units	98
Reach a Drawing Dialog Box	98
Renummer Components Feature	98
Revisions Management	98
Saving Symbols as Palettes	98
Wire Cabling Order Dialog Box	98
Improved Performance in SOLIDWORKS Electrical 3D	98
<b>14 SOLIDWORKS Flow Simulation</b>	<b>100</b>
Associated Goals	100
Customized Visualization Parameters	100
Edit a Two-resistor from Component Explorer	101
Flux Measure on Semitransparent Surfaces	101
Flux Plot	101
Project Parameters	101
Surface Parameters in Sections	101
<b>15 Import/Export</b>	<b>102</b>
Exporting to the PLY File Format	102

Exporting Using Extended Reality.....	102
<b>16 SOLIDWORKS 3D Interconnect.....</b>	<b>104</b>
Exporting to the Revit Family Format 	104
Reading Tessellation Data from Foreign CAD Files 	104
<b>17 SOLIDWORKS Inspection.....</b>	<b>105</b>
SOLIDWORKS Inspection Add-in.....	105
Bill of Characteristics.....	105
Custom Properties .....	106
Hole Table Extraction .....	106
Zone Support .....	107
SOLIDWORKS Inspection Standalone.....	107
SOLIDWORKS PDM Integration .....	107
<b>18 SOLIDWORKS Manage.....</b>	<b>108</b>
Adding a References Folder Structure.....	109
Alternate Options for Mapping Properties.....	109
Bill of Materials Performance.....	109
BOM Tab Content Indicator.....	110
Changing the SOLIDWORKS PDM State Through a Process Output.....	110
Configuration File Utility.....	110
Copying Custom Values in BOM Items.....	111
Document Templates.....	111
Duplicate BOM Line Items.....	111
Export Template Configuration.....	112
Field Group Selection.....	112
Full Web Client.....	113
Hours for Working Days in Projects.....	113
Importing BOM Data from a Microsoft Excel File.....	114
Inactive Configuration Handling in Processes.....	114
Item Detail Pane for BOM View.....	114
Linked Record Objects.....	115
Configuring Linked Records.....	115
Selecting a Linked Record Object.....	115
Defining the Field Mapping.....	116
Defining Related and Reference File Mapping.....	117
BOM Mapping Options.....	117
Mapping the Field Groups to the Linked Record Object.....	117
Numbering Scheme Options.....	118
Creating Linked Records .....	118
Primary References.....	119
List of Recent Documents.....	120
Manual Quantity Synchronization.....	120
Object Type Hyperlinks.....	120

Performance Improvement in Synchronization.....	121
Rich Text in Memo Fields.....	121
SOLIDWORKS PDM Records in Where Used Tab.....	121
Splitting an Auto Number.....	122
Splitting Projects into Stages.....	122
Support for Internal Components.....	123
Thumbnail Images of SOLIDWORKS PDM Files.....	123
Updating SOLIDWORKS PDM Variables.....	123
<b>19 SOLIDWORKS MBD.....</b>	<b>124</b>
3D PDF Files.....	124
Adding Security for 3D PDF Files.....	124
Option to Edit 3D PDF Templates.....	124
CommandManager Tab Renamed.....	125
Copying DimXpert Schemes Across Documents.....	125
Display of Cosmetic Threads and Weld Beads.....	125
Displaying General Tolerances.....	126
Support for Sheet Metal in MBD  .....	126
Text Size in 3D Views.....	127
<b>20 Model Display.....</b>	<b>128</b>
Animation Output File Types.....	128
Model Display Performance Improvements.....	129
Rendering Performance Improvements.....	129
Transforming Textural Appearances with the 3D Texture Tool  .....	129
Applying a Textural Appearance.....	129
Creating 3D Textures.....	131
<b>21 Parts and Features.....</b>	<b>135</b>
Bounding Boxes.....	135
Cosmetic Threads Improvements.....	135
Creating Partial Chamfers and Fillets  .....	136
Deleting Holes from Surfaces.....	138
FeatureWorks Maintains References in Drawing Views.....	138
Inserting a Part with a Specific Configuration  .....	139
Mesh BREP Bodies.....	139
More Tools for Preparing Meshes.....	139
Segment Imported Mesh Body Tool.....	140
Specifying Tolerances for Hole Wizard Holes  .....	143
Thumbnail Preview for Blocks in Design Library.....	144
Using Interference Detection for Multibody Parts  .....	145

<b>22 SOLIDWORKS PCB</b> .....	<b>148</b>
Mechanical Oriented Workflow .....	148
PCB Connector/ECAD-MCAD Collaboration .....	149
Board Thickness .....	149
Copper Support.....	149
Flipping Components.....	149
Multi-contour Hole Sketches.....	149
Silkscreen, Solder Mask, and Solder Paste Support.....	150
SOLIDWORKS PCB Miscellaneous Enhancements.....	150
<b>23 SOLIDWORKS PDM</b> .....	<b>151</b>
Conditional Notifications  .....	151
Defining Conditional Notifications.....	152
Conditional Notification Dialog Box.....	152
Default Search Variable in Search Cards.....	155
Default Values Generation for New Sheets in Drawings  .....	156
Editing History Comments  .....	156
File Shortcut Menu  .....	157
Integrated Installation of Web API Server.....	157
Mixed Authentication Support.....	158
Authenticating Users with Mixed Logins.....	158
Performance Improvements - SOLIDWORKS PDM.....	158
Responsive Redesign in Web2.....	159
Selection of Referenced Drawing Nodes During Change State.....	159
SOLIDWORKS Inspection Integration.....	160
Support for Configurations of Weldment Cut Lists.....	161
Support for DXF/DWG File Format in Convert Task  .....	161
Support for eDrawings Functionality.....	162
Upload and Check in File Structure and Download with References.....	163
User Comments  .....	163
<b>24 SOLIDWORKS Plastics</b> .....	<b>165</b>
Clear Study.....	165
Enhanced Cooling Channel Design.....	165
Geometry-based Boundary Conditions  .....	166
Mesh Enhancements.....	168
Create Mesh Before Saving a Part.....	168
Geometry-based Mesh Control.....	168
Mesh Details.....	169
Simplified Mesh Hierarchy.....	169
Switching Between Mesh Types.....	169



<b>25 Routing</b> .....	<b>170</b>
Configuring Routing Components.....	170
Creating Fixed Length Coverings  .....	171
Fixed Length Covering PropertyManager.....	171
Improved Performance with Routing Library Manager.....	172
Inline Components.....	174
Adding Inline Components to Routes.....	175
Align Components PropertyManager.....	178
<b>26 Sheet Metal</b> .....	<b>180</b>
Linking Materials and Sheet Metal Parameters  .....	180
Tab and Slot.....	181
<b>27 SOLIDWORKS Simulation</b> .....	<b>184</b>
Customized Numerical Format  .....	184
Enhanced Remote Load/Mass PropertyManager  .....	185
Distributed Coupling for Remote Load and Mass  .....	186
Pin Connector  .....	188
Simulation Performance Improvements.....	190
Stress Averaging at Mid-side Nodes.....	191
Topology Study.....	192
Topology Constraints  .....	192
Export to Mesh Body  .....	193
Save Intermediate Topology Results.....	193
<b>28 Sketching</b> .....	<b>195</b>
Editing Generic Splines.....	195
Generic Spline PropertyManager.....	196
Geodesic Entities  .....	198
Pen Tool Sketching Enhancements.....	199
Projected Curve Enhancements.....	200
Slicing Tool.....	201
Slicing Mesh BREP Bodies Using Planar Entities.....	201
Slicing PropertyManager.....	202
Slicing Standard SOLIDWORKS BREP Bodies Using Linear and Point Entities.....	204
Trim Entities Enhancements  .....	206
<b>29 SOLIDWORKS Visualize</b> .....	<b>209</b>
Automatic Data Recovery  .....	209
Customizing Keyboard Shortcuts.....	210

Denoiser ★	210
Importing Files	214
Importing MDL Materials ★	214
Model Tree Behavior	215
Modifying Decal Mapping	215
PBR Materials	215
Physics Simulations	216
Render Options	216
Rendering Solid-Transparent Appearances	216
Video Textures	219
<b>30 Weldments</b>	<b>220</b>
Configuring Cut Lists	220
Structure System	220
Entering Structure System Mode	221
Primary Members	222
Secondary Members	227
Corner Management	230

# Legal Notices

---

© 1995-2018, Dassault Systemes SolidWorks Corporation, a Dassault Systèmes SE company, 175 Wyman Street, Waltham, Mass. 02451 USA. All Rights Reserved.

The information and the software discussed in this document are subject to change without notice and are not commitments by Dassault Systemes SolidWorks Corporation (DS SolidWorks).

No material may be reproduced or transmitted in any form or by any means, electronically or manually, for any purpose without the express written permission of DS SolidWorks.

The software discussed in this document is furnished under a license and may be used or copied only in accordance with the terms of the license. All warranties given by DS SolidWorks as to the software and documentation are set forth in the license agreement, and nothing stated in, or implied by, this document or its contents shall be considered or deemed a modification or amendment of any terms, including warranties, in the license agreement.

## Patent Notices

SOLIDWORKS® 3D mechanical CAD and/or Simulation software is protected by U.S. Patents 6,611,725; 6,844,877; 6,898,560; 6,906,712; 7,079,990; 7,477,262; 7,558,705; 7,571,079; 7,590,497; 7,643,027; 7,672,822; 7,688,318; 7,694,238; 7,853,940; 8,305,376; 8,581,902; 8,817,028; 8,910,078; 9,129,083; 9,153,072; 9,262,863; 9,465,894; 9,646,412; 9,870,436; and foreign patents, (e.g., EP 1,116,190 B1 and JP 3,517,643).

eDrawings® software is protected by U.S. Patent 7,184,044; U.S. Patent 7,502,027; and Canadian Patent 2,318,706.

U.S. and foreign patents pending.

## Trademarks and Product Names for SOLIDWORKS Products and Services

SOLIDWORKS, 3D ContentCentral, 3D PartStream.NET, eDrawings, and the eDrawings logo are registered trademarks and FeatureManager is a jointly owned registered trademark of DS SolidWorks.

CircuitWorks, FloXpress, PhotoView 360, and TolAnalyst are trademarks of DS SolidWorks.

FeatureWorks is a registered trademark of HCL Technologies Ltd.

SOLIDWORKS 2019, SOLIDWORKS Standard, SOLIDWORKS Professional, SOLIDWORKS Premium, SOLIDWORKS PDM Professional, SOLIDWORKS PDM Standard, SOLIDWORKS Simulation Standard, SOLIDWORKS Simulation Professional, SOLIDWORKS Simulation Premium, SOLIDWORKS Flow Simulation, SOLIDWORKS CAM, SOLIDWORKS Manage, eDrawings Viewer, eDrawings Professional, SOLIDWORKS Sustainability, SOLIDWORKS Plastics, SOLIDWORKS Electrical Schematic Standard, SOLIDWORKS Electrical Schematic Professional, SOLIDWORKS Electrical 3D, SOLIDWORKS Electrical Professional, CircuitWorks, SOLIDWORKS Composer, SOLIDWORKS Inspection, SOLIDWORKS MBD, SOLIDWORKS PCB powered by Altium, SOLIDWORKS PCB Connector powered by Altium, and SOLIDWORKS Visualize are product names of DS SolidWorks.

Other brand or product names are trademarks or registered trademarks of their respective holders.

## COMMERCIAL COMPUTER SOFTWARE - PROPRIETARY

The Software is a “commercial item” as that term is defined at 48 C.F.R. 2.101 (OCT 1995), consisting of “commercial computer software” and “commercial software documentation” as such terms are used in 48 C.F.R. 12.212 (SEPT 1995) and is provided to the U.S. Government (a) for acquisition by or on behalf of civilian agencies, consistent with the policy set forth in 48 C.F.R. 12.212; or (b) for acquisition by or on behalf of units of the Department of Defense, consistent with the policies set forth in 48 C.F.R. 227.7202-1 (JUN 1995) and 227.7202-4 (JUN 1995)

In the event that you receive a request from any agency of the U.S. Government to provide Software with rights beyond those set forth above, you will notify DS SolidWorks of the scope of the request and DS SolidWorks will have five (5) business days to, in its sole discretion, accept or reject such request. Contractor/Manufacturer: Dassault Systemes SolidWorks Corporation, 175 Wyman Street, Waltham, Massachusetts 02451 USA.

## Copyright Notices for SOLIDWORKS Standard, Premium, Professional, and Education Products

Portions of this software © 1986-2018 Siemens Product Lifecycle Management Software Inc. All rights reserved.

This work contains the following software owned by Siemens Industry Software Limited:

D-Cubed® 2D DCM © 2018. Siemens Industry Software Limited. All Rights Reserved.

D-Cubed® 3D DCM © 2018. Siemens Industry Software Limited. All Rights Reserved.

D-Cubed® PGM © 2018. Siemens Industry Software Limited. All Rights Reserved.

D-Cubed® CDM © 2018. Siemens Industry Software Limited. All Rights Reserved.

D-Cubed® AEM © 2018. Siemens Industry Software Limited. All Rights Reserved.

Portions of this software © 1998-2018 HCL Technologies Ltd.

Portions of this software incorporate PhysX™ by NVIDIA 2006-2010.

Portions of this software © 2001-2018 Luxology, LLC. All rights reserved, patents pending.

Portions of this software © 2007-2018 DriveWorks Ltd.

© 2011, Microsoft Corporation. All rights reserved.

Includes Adobe® PDF Library technology.

Copyright 1984-2016 Adobe Systems Inc. and its licensors. All rights reserved. Protected by U.S. Patents 5,929,866; 5,943,063; 6,289,364; 6,563,502; 6,639,593; 6,754,382; Patents Pending.

Adobe, the Adobe logo, Acrobat, the Adobe PDF logo, Distiller and Reader are registered trademarks or trademarks of Adobe Systems Inc. in the U.S. and other countries.

For more DS SolidWorks copyright information, see **Help > About SOLIDWORKS**.

## Copyright Notices for SOLIDWORKS Simulation Products

Portions of this software © 2008 Solversoft Corporation.

PCGLSS © 1992-2017 Computational Applications and System Integration, Inc. All rights reserved.

## Copyright Notices for SOLIDWORKS PDM Professional Product

Outside In® Viewer Technology, © 1992-2012 Oracle

© 2011, Microsoft Corporation. All rights reserved.

## Copyright Notices for eDrawings Products

Portions of this software © 2000-2014 Tech Soft 3D.

Portions of this software © 1995-1998 Jean-Loup Gailly and Mark Adler.

Portions of this software © 1998-2001 3Dconnexion.

Portions of this software © 1998-2017 Open Design Alliance. All rights reserved.

The eDrawings® for Windows® software is based in part on the work of the Independent JPEG Group.

Portions of eDrawings® for iPad® copyright © 1996-1999 Silicon Graphics Systems, Inc.

Portions of eDrawings® for iPad® copyright © 2003 – 2005 Apple Computer Inc.

## Copyright Notices for SOLIDWORKS PCB Products

Portions of this software © 2017-2018 Altium Limited.

## Copyright Notices for SOLIDWORKS Visualize Products

NVIDIA GameWorks™ Technology provided under license from NVIDIA Corporation. Copyright © 2002-2015 NVIDIA Corporation. All rights reserved.

# 1

## Welcome to SOLIDWORKS 2019

---

This chapter includes the following topics:

- **Top Enhancements**
- **Performance Improvements**
- **For More Information**

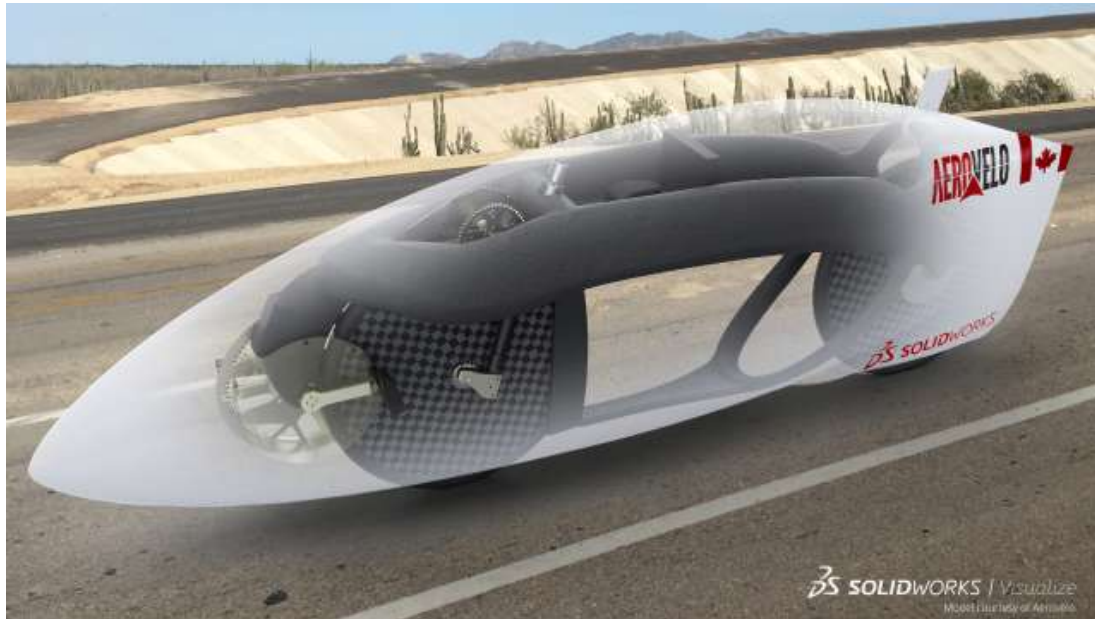

Model courtesy of Aerovelo.

SOLIDWORKS® 2019 delivers many enhancements and improvements, most created in direct response to customer requests.

You can tackle the most complex challenges with SOLIDWORKS 2019 end-to-end process solutions:

- Design to manufacture. Go from concept to manufactured parts even faster.
- Modeling and drawings. Powerful enhancements to improve your design and detailing experience.
- Performance. Faster large assembly design, rendering, and collaboration.
- New technology. Increased productivity when using the latest touch-enabled devices.
- Collaboration. Smart tools for collaborating with partners and suppliers.

# Top Enhancements

The top enhancements for SOLIDWORKS® 2019 provide improvements to existing products and innovative new functionality.

Throughout this guide, look for the  symbol in these areas:

- Assemblies**
  - [Bounding Box in Assemblies](#) on page 37
  - [Create Custom and Configuration-specific Properties in Treehouse](#) on page 61
  - [Defeature PropertyManager - Silhouette](#) on page 40
  - [Exploded Views](#) on page 43
  - [External References](#) on page 43
  - [Use Custom Property for Document Name in Treehouse](#) on page 64
  - [Saving an Assembly as a Part](#) on page 57
  
- Detailing and Drawings**
  - [Changing Cell Border Thickness](#) on page 86
  - [Drawing Open Progress Indicator](#) on page 80
  
- eDrawings**
  - [Configurations in SOLIDWORKS Parts](#) on page 91
  - [eDrawings Professional Features](#) on page 92
  - [Configurations in SOLIDWORKS Assemblies](#) on page 91
  
- SOLIDWORKS 3D Interconnect**
  - [Exporting to the Revit Family Format](#) on page 104
  - [Reading Tessellation Data from Foreign CAD Files](#) on page 104
  
- SOLIDWORKS MBD**
  - [Support for Sheet Metal in MBD](#) on page 126
  
- Model Display**
  - [Creating 3D Textures](#) on page 131
  
- Parts and Features**
  - [Creating Partial Chamfers and Fillets](#) on page 136
  - [Inserting a Part with a Specific Configuration](#) on page 139
  - [Specifying Tolerances for Hole Wizard Holes](#) on page 143
  - [Using Interference Detection for Multibody Parts](#) on page 145
  
- Routing**
  - [Creating Fixed Length Coverings](#) on page 171
  
- Sheet Metal**
  - [Linking Materials and Sheet Metal Parameters](#) on page 180
  
- Sketching**
  - [Geodesic Entities](#) on page 198
  - [Trim Entities Enhancements](#) on page 206

- SOLIDWORKS PDM**
  - [Conditional Notifications](#) on page 151
  - [Default Values Generation for New Sheets in Drawings](#) on page 156
  - [Editing History Comments](#) on page 156
  - [File Shortcut Menu](#) on page 157
  - [Support for DXF/DWG File Format in Convert Task](#) on page 161
  - [User Comments](#) on page 163
  
- SOLIDWORKS Plastics**
  - [Geometry-based Boundary Conditions](#) on page 166
  
- SOLIDWORKS Simulation**
  - [Customized Numerical Format](#) on page 184
  - [Distributed Coupling for Remote Load and Mass](#) on page 186
  - [Enhanced Remote Load/Mass PropertyManager](#) on page 185
  - [Export to Mesh Body](#) on page 193
  - [Pin Connector](#) on page 188
  - [Topology Constraints](#) on page 192
  
- SOLIDWORKS Visualize**
  - [Automatic Data Recovery](#) on page 209
  - [Denoiser](#) on page 210
  - [Importing MDL Materials](#) on page 214

All features are available in SOLIDWORKS Standard, SOLIDWORKS Professional, and SOLIDWORKS Premium unless otherwise noted.

## Performance Improvements

SOLIDWORKS 2019 includes performance and workflow changes across many areas for increased workflow complexity and larger models.

### Installation Manager

The SOLIDWORKS® 2019 Installation Manager uses new download methods that can deliver up to twice the download speed compared to SOLIDWORKS 2018 and earlier.

The new download methods also provide a solution in cases where the Installation Manager failed to download installation files.

### Detailing and Drawings

Performance when creating, opening, and editing hole tables has improved for large numbers of holes and for the combination of circular and noncircular holes.

The time it takes to switch from a model to its drawing under the following conditions is improved:



- Both the model and its drawing are open.
- You make changes in the model that do not change geometry.
- The drawing has multiple sheets.
- **Automatic view update** is on.

## Model Display

SOLIDWORKS 2019 uses a new graphics architecture for parts and assemblies. This architecture provides a more responsive, real-time display especially for large models. It takes advantage of modern OpenGL (4.5) and hardware-accelerated rendering to maintain a high level of detail and frame rate when you pan, zoom, or rotate large models. These performance improvements scale up with the higher-end graphics cards not fully supported in previous versions of SOLIDWORKS. These changes do not apply to drawings.

To turn on the new architecture in SOLIDWORKS 2019, select **Tools > Options > System Options > Performance** and select **Enable graphics performance (Beta feature, requires SOLIDWORKS restart)**.

## Pack and Go

When you select **Include drawings**, an option in **System Options** improves performance by limiting the search for drawings to specific folders. In **Tools > System Options > External References, Include subfolders for drawings search in Pack and Go** searches all subfolders for drawings. If you clear this option, SOLIDWORKS limits its search for drawings to the folders of the packaged models and folders specified in **Tools > Options > File Locations > Referenced Documents**.

## Routing

Improved Feature	Description
Routing Component Wizard	<p>When you use the Routing Component Wizard of the Routing Library Manager, the creation of routing library components is more efficient. The wizard displays only the essential tabs that you use to create routing components for different types of routes. The wizard responds faster when you switch tabs.</p> <p>In the <b>Routing Library Manager &gt; Routing Component Wizard &gt; Design Table Check</b> tab, all component-specific column headers are displayed. The design table information is locked. You can edit column headers in the wizard and click <b>Next</b> to apply the changes to the design table.</p> <p>In the <b>Routing Library Manager &gt; Routing Component Wizard &gt; Component Attributes</b> tab, components with multiple configurations load only the active configuration parameters. Other configuration data is loaded only when you select the configuration in the tab, which accelerates the tab's performance.</p>

Improved Feature	Description
Piping and Tubing Database	<p><b>Removing Components</b> To remove components from the database, in <b>Select Components</b>, select <b>Remove Components</b> and click <b>Save</b>.</p> <p><b>Scanning Components</b> To list components not present in the database, in <b>Scan for library components which are not in the database</b>, click <b>Scan</b>. To include scanned components in the database, select <b>Add Components</b> and click <b>Save</b>.</p> <p>The saving and scanning operations are faster. In <b>Routing Library Manager &gt; Piping and Tubing Database &gt; Select Components &gt; Scan for library components which are not in the database</b>, select <b>Scan excluded folders</b>, and click <b>Scan</b> to scan components in the excluded folders. After the scanning process completes, the table displays components that are not in the database. In the table, you can edit and save <b>Type</b> and <b>Sub Type</b> for components.</p> <p>When you click <b>Save</b>, the SOLIDWORKS software opens and saves only selected components with modified <b>Type</b> or <b>Sub Type</b>, and adds them to the database.</p>
Import Data Dialog Box	<p>In <b>Routing Library Manager &gt; Piping and Tubing Database &gt; Import Data</b>, <b>Start</b> and <b>Synchronize</b> are not available simultaneously, to improve workflow.</p>
Select Route and Component Type	<p>In the Route Component Wizard, the <b>Select Route Type</b> and <b>Select Component Type</b> tabs are combined to improve access.</p>
Design Table Check	<p>In the Routing Component Wizard, when no Design Library exists for a part, the Design Table Check node is available. A message prompts you to create a new design table.</p> <p>Previously, if no design table existed for a part, the Design Table Check node was unavailable and there was no option to create a new design table.</p>
Images for Connectors in the Routing Library Manager	<p>The Routing Library Manager includes images in <b>Route and Component Types</b>, <b>Routing Geometry</b>, and <b>Routing Functionality Points</b> nodes of the Routing Component Wizard tab.</p> <p>The images help you identify the components.</p>

## Toolbox

You can temporarily disable the automatic update of mates between a Toolbox component and a non-Toolbox component by clearing **Automatic Update for Toolbox Mates**. By disabling the automatic update, you can improve performance by making it quicker to edit mates, add mates, and manipulate components.

When you disable automatic mate updates:

- Toolbox fasteners do not move if you move the components to which they are mated. Non-Toolbox components do move.
- Performance improves when working in assemblies with several Toolbox components inserted and mated at the top level. For example, in assemblies with hundreds of fastener stacks at the top level, updating these mates can impact assembly performance when performing actions like solving mates, adding mates, and dragging components.

Performance improvements do not occur when Toolbox components are:

- In subassemblies because the option affects solving mates at the top level only.
- Patterned, because patterned instances do not use mates.

You must disable **Automatic Update for Toolbox Mates** each time you open an assembly. See [Disabling Automatic Mate Updates in Toolbox](#) on page 51.

## SOLIDWORKS Electrical 3D

The performance is improved for **Route Cables** and **Route Harness** tools. The performance is faster when you use the **Route Wires** tool for routing of a large number of wires in an assembly.

When you click **Tools > SOLIDWORKS Electrical > Electrical Component Wizard**, Route Library Manager starts quickly and you can define components faster for SOLIDWORKS Electrical 3D.

## SOLIDWORKS PDM

SOLIDWORKS PDM has improved performance of loads for large assemblies and complex reference structures in the Contains and Where Used tabs.

You can more quickly complete operations such as moving, dragging, browsing, renaming files, and adding a large number of files to a folder that has many files. You can also check in assemblies with virtual components much faster.

Browsing speed has improved while working on integrated search results.

The elimination of unnecessary interface refreshes speeds up your browsing experience, including folders with many locally cached files.

## SOLIDWORKS Manage

Performance is improved when you synchronize SOLIDWORKS PDM objects with a large number of files and folders. The Synchronization details dialog box displays the synchronization steps.

**To open the Synchronization details dialog box:**

1. Edit a SOLIDWORKS PDM object.

2. In the dialog box, navigate to the Connection page.
3. Select **Show synchronization steps**.
4. Click **OK**.

## Simulation

The latest Intel® Parallel Studio XE 2018 Cluster Edition replaces the existing Intel Fortran compiler, the Intel Math Kernel Library (MKL), and Intel MPI libraries used by the solvers.

The latest Intel 2018 Fortran compiler is used for part of the code that prepares data for the FFEPlus, Direct Sparse, and Intel Direct Sparse solvers, and computes stresses and strains. The Direct Sparse and the Intel Direct Sparse solvers are using the latest Intel 2018 MKL.

Improvements in overall stability are expected as part of this upgrade.

In addition, the Intel Direct Sparse solver is reconfigured for optimized performance for Linear static studies with multiple Load Cases. Improvement in solution time is observed for up to 25 load cases.

These improvements apply to the optimized solver performance for linear static studies with multiple load cases:

- Only the Intel Direct Sparse solver (IDS) is configured for highly optimized performance. If you select the Direct Sparse or the Large Problem Direct Sparse solvers, the software switches internally to the IDS solver.
- This improves solver performance for Pressure, Force, and Torque load types. All other load types, connectors, and non-zero prescribed displacements should be exactly the same in all load cases to observe performance benefit. Load cases in the Load Case Manager are grouped together internally in such a way that load cases with similar features (such as mentioned above) are run together with the optimized performance scheme. Load cases with dissimilar features are run without any such optimization.
- The optimized solver performance is not activated when no-penetration contact or virtual wall contact are present in any load case, and also in a case of a distributed beam load, which varies across load cases.
- For a typical linear static study solved by the IDS equation solver, the most time-consuming part of the solution is the factorization of the global stiffness matrix, which consumes the majority of the total solution. In the optimized performance scheme, this factorization is done only once as the stiffness matrix is exactly the same for every load case. During the non-optimized performance scheme, the same factorization is repeated for the solution of each load case.

## eDrawings

View manipulations and assembly component selections are faster in eDrawings®.

To improve performance, click **Tools > Options > General** and select **Graphics boost** and **Fastest speed**.

## For More Information

Use the following resources to learn about SOLIDWORKS:

**What's New in PDF and HTML**

This guide is available in PDF and HTML formats. Click:

- **Help > What's New > PDF**
- **Help > What's New > HTML**

**Interactive What's New**

In SOLIDWORKS, click the  symbol to display the section of this manual that describes an enhancement. The symbol appears next to new menu items and the titles of new and changed PropertyManagers.

To enable Interactive What's New, click **Help > What's New > Interactive**.

**Sample files**

To open sample files for this book, go to

`system_dir:\Users\Public\Public Documents\SOLIDWORKS\SOLIDWORKS 2019\samples\whatsnew\chapter_name\file_name.`

For example, `C:\Users\Public\Public Documents\SOLIDWORKS\SOLIDWORKS 2019\samples\whatsnew\sketching\Block.sldprt.`

**Online Help**

Contains complete coverage of our products, including details about the user interface, samples, and examples.

**Release Notes**

Provides information about late changes to our products, including changes to the *What's New* book, online help, and other documentation.

# 2

## User Interface

---

This chapter includes the following topics:

- **Breadcrumbs Enhancements**
- **Customizing Task Pane Tabs**
- **Improved Preview for Minimized Documents**
- **Keyboard Accessibility**
- **Markups for Collaboration**
- **Measure Tool**
- **Microsoft Surface Dial in SOLIDWORKS**
- **Open Dialog Box**
- **Opening Part Configurations in Quick View Mode**
- **Recent Documents Improvements**
- **Rollback Bar Drag Interaction**
- **Status Feedback**
- **Touch Mode**

### Breadcrumbs Enhancements

You can select multiple mates in the selection breadcrumbs and display the breadcrumbs in a semitransparent state at the pointer.

**To access this option:**

1. Click **Tools > Options > System Options > Display** and select **Show breadcrumbs at mouse pointer**.
2. Click the part or assembly.

### Customizing Task Pane Tabs

You can reorder, show, or hide tabs in the Task Pane. You can also specify the default tab that opens when you open the Task Pane.

**To customize the Task Pane:**

1. Right-click any Task Pane tab or the header of the Task Pane and click **Customize**.

2. In the Customize dialog box, do the following:
    - To show or hide Task Pane tabs, select or clear check boxes.
    - To reorder, drag the tab titles.
    - To specify a tab as default, under **Default**, click the corresponding button.
  3. Click anywhere in the graphics area to close the Customize dialog box.
- The SOLIDWORKS software saves the new settings. When you relaunch the software, the Task Pane tabs use the customized settings.

## Improved Preview for Minimized Documents

You can hover over the title bar of a minimized document to see its name, thumbnail, and path.

## Keyboard Accessibility

You can use the keyboard to access tools in shortcut bars, shortcut menus, and context toolbars in the graphics area.

### Shortcut Bars

<b>Arrow keys</b>	Navigates through the tools on the shortcut bar.
<b>Alt + Down arrow</b>	Opens the menu, if available, of the selected tool.
<b>Enter</b>	Executes the selected tool.
<b>Esc</b>	Dismisses the shortcut bar or the tool's menu.

### Shortcut Menus and Context Toolbars

<b>Shift +F10 or menu key</b>	Opens the shortcut menu.
<b>Arrow keys</b>	Navigates through the menu and toolbar items.
<div style="border: 1px solid gray; padding: 5px; width: fit-content; margin: 0 auto;"> <p>When a context toolbar appears on its own in the graphics area (without a shortcut menu), the context toolbar does not support keyboard navigation.</p> </div>	
<b>Enter</b>	Executes the selected menu item or tool.

---

<b>Esc</b>	Dismisses the shortcut menu, context toolbar, or a tool's menu.
------------	---

---

## Markups for Collaboration

You can use sketch tools to create, view, edit, and delete markups for parts and assemblies. You can save the markups as .pdf, .jpeg, .png, .bmp, and .tiff files for collaboration purposes.

### To access the markup tools:

1. Click **Tools > Options > System Options > FeatureManager > Markups > Show** and click **OK**.
2. In the FeatureManager® design tree, right-click the **Markups** folder  and click **Insert Markup View**.

The **Ink Markup** toolbar appears.



You can start the **Markup View**  tool from **Evaluate > Markup View** on the CommandManager.

Sketch and Ink markups are limited to pen and touch-enabled devices that use Windows 10, version 1703 or later. For all other devices, you can only add markup notes using the keyboard.

## Measure Tool

The **Measure** tool is available for all SOLIDWORKS tools used for part, assembly, and drawing files. You can use the tool even while other tools are running.

## Microsoft Surface Dial in SOLIDWORKS

The SOLIDWORKS software supports the Microsoft® Surface Dial. Surface Dial lets you view model attributes and zoom, pan, or rotate models.

With the SOLIDWORKS program active, press and hold the Surface Dial on-screen or off-screen to show the radial menu. The menu includes the system options **Volume**, **Scroll**, and **Undo** and the custom ring options **Pan**, **Zoom**, and **Rotate**. Click a custom option to show the custom ring.

On the custom ring, tap **Pan**, **Zoom**, or **Rotate** with your finger to select the tool. When you select **Pan**, press the dial to activate the X or Y axis or rotate the dial to pan along the active axis. When you select **Rotate**, press the dial to activate the X, Y, or Z axis. Rotate the dial to rotate the current view along the active axis.



When you use the off-screen dial, the custom ring appears on the lower-right corner of the graphics area for right-hand dominance and the lower-left corner for left-hand dominance. You can drag the custom ring anywhere on the screen.

## Open Dialog Box

In the Open dialog box, if you select one or multiple files of the same type and click **Options**, the System Options dialog box displays the options for the selected file type.



## Opening Part Configurations in Quick View Mode

When you open a part in Quick view mode, you can specify the configuration to open. You can also do this in eDrawings®.

Before you open a specified configuration in Quick view mode, you need to specify which configurations are available in Quick view mode. Open the part in Resolved mode first to determine which configurations are visible to other users.

### To open part configurations in Quick view mode:

1. Open `system_dir:\Users\Public\Public Documents\SOLIDWORKS\SOLIDWORKS 2019\samples\whatsnew\user interface\jack_parts.sldprt`.
2. In the ConfigurationManager, right-click the following configurations and click **Add Display Data Mark**:
  - **Base**
  - **Outer**

**Base** and **Outer** are marked with  icons. The other configuration remains the same.
3. Save and close the part.
4. Click **Open**  or **File > Open**.

5. In the dialog box:
  - a) Select `jack_parts.sldprt`.
  - b) In **Mode**, select **Quick view**.
  - c) In **Configurations**, select **Outer**.  
Only the **Base** and **Outer** configurations are available to select.
  - d) Click **Open**.

The part opens in the **Outer** configuration in Quick view mode. The **Base** and **Outer** configurations are available in the ConfigurationManager.

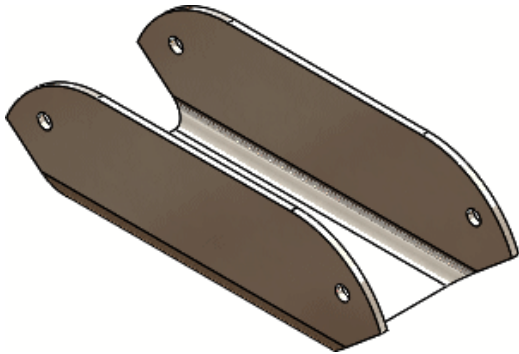

## Recent Documents Improvements

The SOLIDWORKS software can save more recent documents and they are easier to manage.

- The SOLIDWORKS software can store up to 100 recent documents.
- You can specify the maximum number of recent documents from 1 to 100 in **System Options**. The default number is 50.
- You can include documents opened from other documents by selecting **Include documents opened from other documents** in **System Options**.
- You can filter recent documents by type and by name on the **Recent > Documents** tab in the Welcome dialog box.
- You can remove some or all recent items by clicking **Remove** in the **Recent > Documents** or **Recent > Folders** tabs in the Welcome dialog box.

# Rollback Bar Drag Interaction

Handles in touch mode make it easier to interact with the freeze bar and the rollback bar.

## Status Feedback

A SOLIDWORKS dialog box may appear during lengthy processes when Microsoft® Windows® detects that the SOLIDWORKS software has stopped responding. You can wait for the command to finish (recommended) or close the SOLIDWORKS software.

If you choose to close the SOLIDWORKS software when the dialog box appears, you can send your comments and performance log data to DS SolidWorks Corp (also recommended). This benefits all users and helps improve the software's performance and stability.

Previously, a Windows Not Responding dialog box appeared when Microsoft Windows detected that the SOLIDWORKS software was no longer responding, even when SOLIDWORKS was working normally.

## Touch Mode

When you use touch gestures, you can work in a more direct way with your content.

- When you select an entity in the graphics area, the **Copy** tool appears in the touch toolbar. Turn on the Copy tool and drag the selected entity to copy and move it.
- Select + drag to move entities. You can touch the entities to select them and then drag your finger to move them.
- While sketching an entity, if you hold your finger on the screen around an area for some time, the **Selection** tool appears around your finger. To turn it off, click **Tools > Options > System Options > Touch** and clear **Automatically pop up Selection tool while hunting for precise location**. The **Selection** tool helps in precise selection of vertices, edges, and small faces.
- **Rotate lock** turns on when you enter sketch mode and turns off when you exit sketch mode. The **Rotate lock** tool locks 3D rotate and 2D roll.
- Icons around the pointer and tooltips are moved to the upper-left side of the pen for right-handed users and upper-right side for left-handed users to solve occlusion problems. The same applies to stylus and touch input methods.
- When you unpin the Task Pane, tap anywhere in the graphics area to collapse the Task Pane.

# 3

## SOLIDWORKS Fundamentals

---

This chapter includes the following topics:

- **Application Programming Interface**
- **Changes to System Options and Document Properties**
- **Specifying a Default Save Folder**

### Application Programming Interface

See *SOLIDWORKS API Help: Release Notes* for late-breaking updates.

SOLIDWORKS® 2019 API includes the ability to:

- Access Bounding Box feature data.
- Access Ground Plane feature data.
- Access Tab and Slot feature data.
- Convert an existing balloon to a stacked balloon.
- Create a geodesic sketch offset along the curvature of a surface.
- Create a pattern feature with a smaller subset of parameters and then extend or modify it using a pattern-specific feature data object.
- Create an assembly mate with a smaller subset of parameters and then extend or modify it using a mate-specific feature data object.
- Get a component's suppression state or, if an internal ID mismatch exists, an error code.
- Get an annotation's text scale in the 3D View.
- Get data from the Hole Wizard database.
- Get or set more properties on linear, linear component, and circular component pattern features.
- Get or set more table column types, including the equation-driven type.
- Get or set the orientation of text in table cells.
- Get or set whether an angle or distance mate is a limit mate.
- Get or set whether to bidirectionally project a curve.
- Get or set whether to enable the pushpin of an add-in's callout.
- Get or set whether to enable the **Select Identical Components** menu item in the context menu of a PropertyManager page selection box.
- Get or set whether to exclude a component from the bills of materials in specified configurations.
- Get or set whether to generate a display list for a part's configuration.
- Get or set whether to load external references in memory when opening a document.

- Get or set whether to reverse the direction of a specified reference of a reference plane feature.
- Get the error status of an assembly mate.
- Insert a Delete Hole feature for selected hole edges on a surface.
- Insert, open, and update models developed in other CAD packages.
- Repeatedly detect collisions among groups of components in a variety of transformations.
- Specify whether to include a specified component when saving an assembly as a part.

## Changes to System Options and Document Properties

The following options have been added, changed, or removed in the software.

### System Options

These system options are accessible at **Tools > Options > System Options**. The Access column lists which subarea of **System Options** that the option is located.

Option	Description	Access
<b>Maximum recent documents displayed</b>	Specifies the maximum number of recent documents displayed ranging from 1 to 100.	<b>General</b>
<b>Include documents opened from other documents</b>	Includes documents opened from other documents in the list of recent documents.	<b>General</b>
<b>Allow cosmetic threads for upgrade</b>	Specifies that all parts, assemblies, and drawings that use legacy cosmetic threads are marked for using improved cosmetic threads. The upgrade requires you to set this system option first, and then you can enable the upgrade for each model.	<b>General</b>
<b>Allow editing of templates for 3D PDF files</b>	Lets you edit the templates that you use when you create 3D PDF files for MBD.	<b>MBD</b>
<b>Display scrollbars in graphics view for parts and assemblies</b>	(Not available if any documents are open in SOLIDWORKS.) Displays scrollbars in part and assembly document windows.	<b>Display</b>
<b>Display scrollbars in graphics view for drawings</b>	(Not available if any documents are open in SOLIDWORKS.) Displays scrollbars in drawing document windows.	<b>Display</b>

Option	Description	Access
<b>Show breadcrumbs at mouse pointer</b>	Lets you select multiple mates in the selection breadcrumbs and display the breadcrumbs in a semitransparent state at the pointer.	<b>Display</b>
<b>No preview during open</b>	Removed from the software.	<b>Performance</b>
<b>Include subfolders for drawings search in Pack and Go</b>	Limits the search for drawings to specific subfolders. If you clear this option, the software limits its search to the folders of the packaged models and folders specified in <b>Tools &gt; Options &gt; File Locations &gt; Referenced Documents</b> .	<b>External References</b>
<b>Default Save Folder</b>	Specifies the default folder where new documents are saved. If you do not specify this path, the default save folder varies based on the last used folder.	<b>File Locations</b>
<b>Edit name with slow double click</b>	Lets you click-pause-click items in the FeatureManager® design tree to rename them. When cleared, you can still rename items by selecting them and pressing <b>F2</b> .	<b>FeatureManager</b>
<b>Markups</b>	Creates markups for parts and assemblies using sketching tools.	<b>FeatureManager</b>
<b>Automatically pop up Selection tool while hunting for precise location</b>	While sketching an entity, if you hold your finger on the screen around an area for some time, the <b>Selection</b> tool appears around your finger.	<b>Touch</b>
<b>Lock rotation of new concentric mates to Toolbox components</b>	Automatically locks rotation for new concentric mates to Toolbox components.	<b>Hole Wizard/Toolbox</b>
<b>PLY</b>	Exports SOLIDWORKS parts and assemblies to the .ply file format.	<b>Export &gt; PLY</b>
<b>SLDPRT from assembly</b>	Specifies export options when you save an assembly as a part.	<b>Export &gt; SLDPRT from assembly</b>
<b>Export SOLIDWORKS assembly envelope</b>	Lets you import envelopes when you open SOLIDWORKS assemblies that contain envelopes.	<b>Export &gt; SMG</b>

Option	Description	Access
<b>Export SOLIDWORKS PMI</b>	Specifies that SOLIDWORKS Composer imports Product Manufacturing Information (PMI) data from SOLIDWORKS models.	<b>Export &gt; SMG</b>

## Document Properties

These document properties are accessible at **Tools > Options > Document Properties**. The Access column lists which subarea of **Document Properties** that the option is located.

Option	Description	Access
<b>Do not add "QTY" next to configuration name</b>	Removed from software. Replaced by options in the <b>Top level Only BOM</b> , <b>Parts Only BOM</b> , and <b>Indented BOM</b> group boxes.	<b>Tables &gt; Bill of Materials</b>
<b>Do not copy QTY column name from template</b>	Removed from software. Replaced by options in the <b>Top level Only BOM</b> , <b>Parts Only BOM</b> , and <b>Indented BOM</b> group boxes.	<b>Tables &gt; Bill of Materials</b>
<b>Combine cutlist items in BOM regardless to profile when lengths are changed to be same (legacy behavior)</b>	Controls how cut list items are grouped in the BOM when you change their lengths to be the same. <ul style="list-style-type: none"> <li>Selected: Combines those same-length cut list items even if they have different profiles. This is the behavior used in SOLIDWORKS 2018 and earlier.</li> <li>Cleared: Combines only those same-length cut list items with identical profiles. Cut list items with different profiles remain separate, even if their lengths are changed to be the same.</li> </ul> <div style="border: 1px solid gray; padding: 5px; margin-top: 10px;"> <p>Turning this option on or off might affect the behavior of existing BOMs in the active document if you then edit the lengths of cut list items.</p> </div>	<b>Tables &gt; Bill of Materials</b>

Option	Description	Access
<b>Top level Only BOM, Parts Only BOM, and Indented BOM</b>	<p>For each type of bill of materials, uses the following options to show or hide custom text and the configuration name independently.</p> <ul style="list-style-type: none"> <li>• <b>Show custom text in BOM header.</b> In the header of the <b>Quantity</b> column, replaces the template-specified text with text that you type in <b>Custom text</b>. For a blank header, select this option and leave <b>Custom text</b> empty.</li> <li>• <b>Show configuration in BOM header.</b> Adds the configuration name to the header of the <b>Quantity</b> column.</li> </ul>	<b>Tables &gt; Bill of Materials</b>
<b>Sheet Metal MBD</b>	New section of the Document Properties dialog box where you can specify color, line type, and other options for various sheet metal items.	<b>Sheet Metal MBD</b>
<b>Use sheet metal parameters from material</b>	Specifies whether new sheet metal bodies inherit sheet metal parameters defined in the material applied to the existing sheet metal bodies.	<b>Sheet Metal</b>

## Specifying a Default Save Folder

You can specify the default folder where new documents are saved. If you do not specify this path, the default save folder varies based on the last used folder.

When you save a document with **Save As**, the file uses the path of the active document, even if you have specified a default save folder.

### To specify the default save folder:

1. Click **Options**  or **Tools > Options** and select **File Locations**.
2. Under **Show folders for**, select **Default Save Folder** from the list.
3. Click **Add** to select a folder location.
4. Click **OK**.



# 4

## Installation

---

This chapter includes the following topics:

- **Faster Download**

### Faster Download

The Installation Manager uses new download methods that can deliver up to twice the download speed compared to SOLIDWORKS 2018 and earlier.

The new download methods also provide a solution in cases where the Installation Manager failed to download installation files.

# 5

## Administration

---

This chapter includes the following topics:

- [Admin Portal](#)
- [Comparing Geometry in the Upgrade Assistant](#)
- [Improved Performance with Pack and Go](#)
- [Improved Problem Capture in SOLIDWORKS Rx](#)
- [Language Translation for Settings Administrator Tool](#)

### Admin Portal

#### Assign Members to a Product

The Product Details page includes an **Available Members** section that you can use to assign new members to a product.

To find a member, you can filter the **Available Members** section based on:

- First name
- Last name
- Email
- Product type

#### Filter Products and Services

On the Products and Services tabs of the Members Detail page, you can filter the available products and services. This reduces the time required to find the product or service you want to assign to a member. You can filter by criteria such as:

- Product or Service name
- Serial number
- Subscription status
- Assignment status
- Activation type
- Product or Service type

## Comparing Geometry in the Upgrade Assistant

The Upgrade Assistant reports if the center of mass or volume of the model has changed.

This data is useful when detecting if a model is rebuilding differently in a new version, but not necessarily failing. If there are significant differences between the current version of the software and the baseline, the center of mass and volume are highlighted in blue in the report.

Previously, the Upgrade Assistant only identified performance changes, rebuild errors, drawing pixel changes (color and position), and stability problems.

## Improved Performance with Pack and Go

When you select **Include drawings**, an option in System Options improves performance by limiting the search for drawings to specific folders. The option **Include subfolders for drawings search in Pack and Go** in **Tools > System Options > External References** searches all subfolders for drawings. If you clear this option, the software limits its search for drawings to the folders of the packaged models and folders specified in **Tools > Options > File Locations > Referenced Documents**.

## Improved Problem Capture in SOLIDWORKS Rx

Enhancements in problem capturing with SOLIDWORKS Rx include:

- You can restart the video recording without shutting down the SOLIDWORKS software when you cannot capture an event on the first attempt.

To restart the recording, click **Restart** to delete the current video and then **Record** to record a new video.

- SOLIDWORKS no longer shuts down when you **Finish** a video capture.
- You can pause a recording.

To pause the recording, click **Pause** and **Resume** to record.

- You can record the entire screen instead of just the SOLIDWORKS window.

Previously, you could start capturing, run the SOLIDWORKS software, and place another application window in front of the SOLIDWORKS window.

- Maximum video length has increased from 5 to 10 minutes.

# Language Translation for Settings Administrator Tool

The Settings Administrator is translated in all languages supported by the SOLIDWORKS software.

The Settings Administrator tool runs using the language setting of your Microsoft® Windows® operating system or English if your language is not supported.

# 6

## Assemblies

---

This chapter includes the following topics:

- **Bounding Box in Assemblies**
- **Bounding Box PropertyManager**
- **Component Preview Window**
- **Cosmetic Threads**
- **Defeature PropertyManager - Silhouette**
- **Defeature - Define Groups**
- **Exploded Views**
- **External References**
- **Large Design Review**
- **Lightweight Mode**
- **Mates**
- **Patterns**
- **Performance Evaluation**
- **Saving an Assembly as a Part**
- **Select Identical Components**
- **Treehouse**
- **Warning When Inserting Complex Components**

## Bounding Box in Assemblies

You can create a bounding box feature in an assembly that contains geometry. The bounding box is calculated by using the same methods as the part-level bounding box.

An assembly can contain only one **Bounding Box**  feature. In the FeatureManager® design tree, you can right-click the bounding box, and click **Hide**, **Show**, **Suppress**, or **Unsuppress**.

Different colors indicate the component-level bounding box sketches in the graphics area:

Top-level assembly bounding box	Gray
Subassembly bounding box	Blue
Part bounding box	Orange

To view a bounding box, click **View > Hide/Show > Bounding Box**.

To view bounding box properties, hover over **Bounding Box**  in the FeatureManager design tree, or click **File > Properties > Configuration Specific**. Values are listed for the length, width, thickness, and volume of the bounding box.

## Bounding Box Calculations

Bounding box calculations include SpeedPak faces and bodies but do not include SpeedPak ghost graphics. After creating a bounding box feature, you can insert a SpeedPak subassembly into the assembly or change an existing component to SpeedPak in the assembly.

In an active assembly, bounding box calculations do not update dynamically when components change in the assembly. A **Rebuild**  icon appears next to the bounding box feature when you need to recalculate. Right-click **Bounding Box** and click **Update** to rebuild.

The time required to calculate the bounding box feature appears in the **Assembly Rebuild Report**. To access this report, click **Tools > Evaluate > Performance Evaluation** and expand the **Rebuild Performance** section.

# Bounding Box PropertyManager

**To open the Bounding Box PropertyManager:**

Click **Insert > Reference Geometry > Bounding Box**.

Specify these options to create a bounding box.

## Reference Face/Plane

<b>Best Fit</b>	Uses the X-Y plane for the orientation of the bounding box.
<b>Custom Plane</b>	Specifies a reference plane to use for the bounding box.

## Options

<b>Include hidden components</b>	Includes hidden components in the bounding box calculations.
<b>Include envelope components</b>	Includes envelope components in the bounding box calculations.
<b>Include hidden bodies</b>	Includes bodies that are hidden at the part level in the bounding box calculations.
<b>Include surfaces</b>	Includes surface bodies in the bounding box calculations.

---

<b>Show Preview</b>	Displays a preview of the bounding box in the graphics area.
---------------------	--

---

## Component Preview Window

You can view multiple components in the Component Preview window. You can use

**Synchronize**  to synchronize the Component Preview window with the assembly window. You can change the display style of the selected components for the assembly window.

Most of the assembly window tools are available with the Component Preview window. Some tools that are not available include **Isolate**, **Viewport**, **New Window**, and **Close All**.

You cannot select hidden, suppressed, or graphics-only components to view in the Component Preview window.

The Component Preview window is not available in the following situations:





- **Isolate** is active.
- More than one viewport is open.
- Editing a component in-context.

To open the Component Preview window, select a component and click **Tools** >

**Component** > **Preview Window** .

Component Preview window options:

---

	<b>Visible</b>	
	<b>Wireframe</b>	
	<b>Transparent</b>	
	<b>Hidden</b>	
	<b>Synchronize</b>	Aligns the Component Preview window with the assembly window when you change the orientation or use a zoom tool like <b>Zoom to Fit</b> or <b>Zoom to Area</b> .
	<b>Exit Preview</b>	Closes the Component Preview window.

---

# Cosmetic Threads

Cosmetic threads quality is improved for assemblies and parts. To use the improvements for legacy assemblies, upgrade the cosmetic threads features.

For information about the improvements and the upgrade process, see [Cosmetic Threads Improvements](#) on page 135.



## Defeature PropertyManager - Silhouette

You can simplify a complex assembly by using the Silhouette method in the Defeature PropertyManager. You define groups of bodies or components and then define a simplification method for these groups.

Simplification methods include:

- **Bounding Box**
- **Cylinder**
- **Polygon Outline**
- **Tight Fit Outline**
- **None (Copy Geometry)**



The simplified geometry is saved in a part in the same way as the existing Simplified geometry method in the Defeature PropertyManager. If you retain a link to the parent assembly, changes to the parent assembly change the simplified model when you update the model.

When you create a part after defeature, a folder  for each defeature group shows in the FeatureManager design tree. If you select **Merge groups after this step**, the folder name is named **Merged**. The folder contains a feature  for each body generated by the simplification.

## Defeature - Define Groups

You can use the Silhouette method to define groups of bodies or components and then define a simplification method for these groups.

**To use the Silhouette method in the Defeature PropertyManager:**

1. Click **Tools** > **Defeature** .
2. In the PropertyManager, under **Defeature Method**, click **Silhouette** .
3. Click **Next** .



Specify options for the Silhouette method:



## Groups

<b>Groups</b>	<p>Lists the defeature groups.</p> <p>When you add or edit a group, an asterisk (*) appears next to the group name until you click <b>OK</b> or <b>Cancel</b> in the PropertyManager.</p> <p>When you select a group, the bodies in that group are highlighted in the Preview window.</p>
<b>Merge groups after this step</b>	Merges groups that touch or overlap.
<b>Highlight processed bodies</b>	Highlights the bodies that are included in the defeature groups. The bodies are highlighted using the <b>Selected Item 4</b> color.





## Add a Group / Edit a Group

	<b>Name</b>	Lists the group name.
	<b>Components</b>	Lists the components in the group.
	<b>Bodies</b>	Lists the bodies in the group.
	<b>Add Group</b>	<p>Adds the group.</p> <p>Available in Add a Group mode.</p>
	<b>Reset</b>	<p>Resets the options.</p> <p>Available in Add a Group mode.</p>
	<b>OK</b>	<p>Saves changes to the group. Switches to the Add a Group mode.</p> <p>Available in Edit a Group mode.</p>
	<b>Cancel</b>	<p>Resets the options.</p> <p>Available in Edit a Group mode.</p>
	<b>Apply</b>	<p>Saves changes to the group. Remains in the Edit a Group mode.</p> <p>Available in Edit a Group mode.</p>

## Simplification Method

<b>Simplification Method</b>	<b>Bounding Box</b>	Creates a cuboid bounding box.
	<b>Cylinder</b>	Creates a cylinder derived from the dimensions of a cuboid bounding box.
	<b>Polygon Outline</b>	Creates an extruded polygon that fits around the outline of the selected bodies and components.
	<b>Tight Fit Outline</b>	Creates an extruded body by using the outlines of the selected bodies and components.
	<b>None (Copy Geometry)</b>	Creates an exact copy of the selected bodies and components.
<b>Enclose in one body</b>	<p>Creates a single body that includes the selected entities. Available when you select at least one body or component, and one of the following methods:</p> <ul style="list-style-type: none"> <li>• <b>Bounding Box</b></li> <li>• <b>Polygon Outline</b></li> <li>• <b>Tight Fit Outline</b></li> </ul> <p>For <b>Polygon Outline</b>, the selected entities must touch or overlap.</p>	
<b>Ignore small bodies (% of assembly size)</b>	Ignores bodies or components based on their size in relation to the top-level assembly.	
<b>Keep internal loops</b>	Includes internal loops in the resulting body if the silhouette of the selected entities contains these loops. Available for <b>Tight Fit Outline</b> .	



## Orientation

 <b>Custom Plane</b>	Specifies the plane to use for the group. Select a plane or click <b>Automatic</b>  , <b>Front</b>  , <b>Top</b>  , or <b>Right</b>  .
<b>Use multiple directions</b>	Specifies a plane or face to use for a second direction. Available for <b>Polygon Outline</b> and <b>Tight Fit Outline</b> .



## Exploded Views

You can go through an exploded view step-by-step. You can roll back an exploded view to see the results of each step.

### To open the Explode PropertyManager for an existing exploded view:

1. On the ConfigurationManager  tab, expand the configuration.
2. Right-click **Exploded View**  and click **Edit Feature** .

You can use the following functionality in the PropertyManager:

- Modify the name for a new or existing step.
- Insert a step above the rollback bar.
- Drag an active step to reorder the steps.
- Resize the height of the Explode Steps box.
- Click **Add Step** to add a step.
- Click **Reset** to reset options.
- Click **Roll Back**  and **Roll Forward**  to roll back or roll forward steps.
- Suppress a step. Suppressed steps are not shown in the graphics area for Explode Steps or Smart Explode Lines. Suppressed steps remain suppressed regardless of the rollback bar position.
- Specifies the default name to **Explode Step** + number. When you select **Auto-space components on drag**, the default explode step name is **Chain** + number.

In the Exploded Steps PropertyManager and ConfigurationManager, you can roll back or roll forward steps by dragging the rollback bar.





Right-click a step located above the rollback bar to access the following tools:

- **Roll Back**
- **Suppress**

Right-click a step located below the rollback bar to access the following tools:

- **Roll Forward**
- **Roll to Previous**
- **Roll to End**

For the Animation Controller, the following controls changed:

- **Fast forward**  renamed to **Next step**.
- **Rewind**  renamed to **Previous step**.
- **Stop**  has been removed.
- **Play**  and **Pause**  are shared in one control.

## External References

The External References dialog box for parts and features, and the External References dialog box for assemblies are combined into one dialog box. You can break, unlock, or

lock individual references for features and sketches, sort references by status, and isolate selected components.

While the External References dialog box is open, you can interact with the FeatureManager design tree and the model in the graphics area. You can enable **Dynamic Reference Visualization** to view feature dependencies. You cannot drag files into the SOLIDWORKS software.

### To open the External References dialog box:

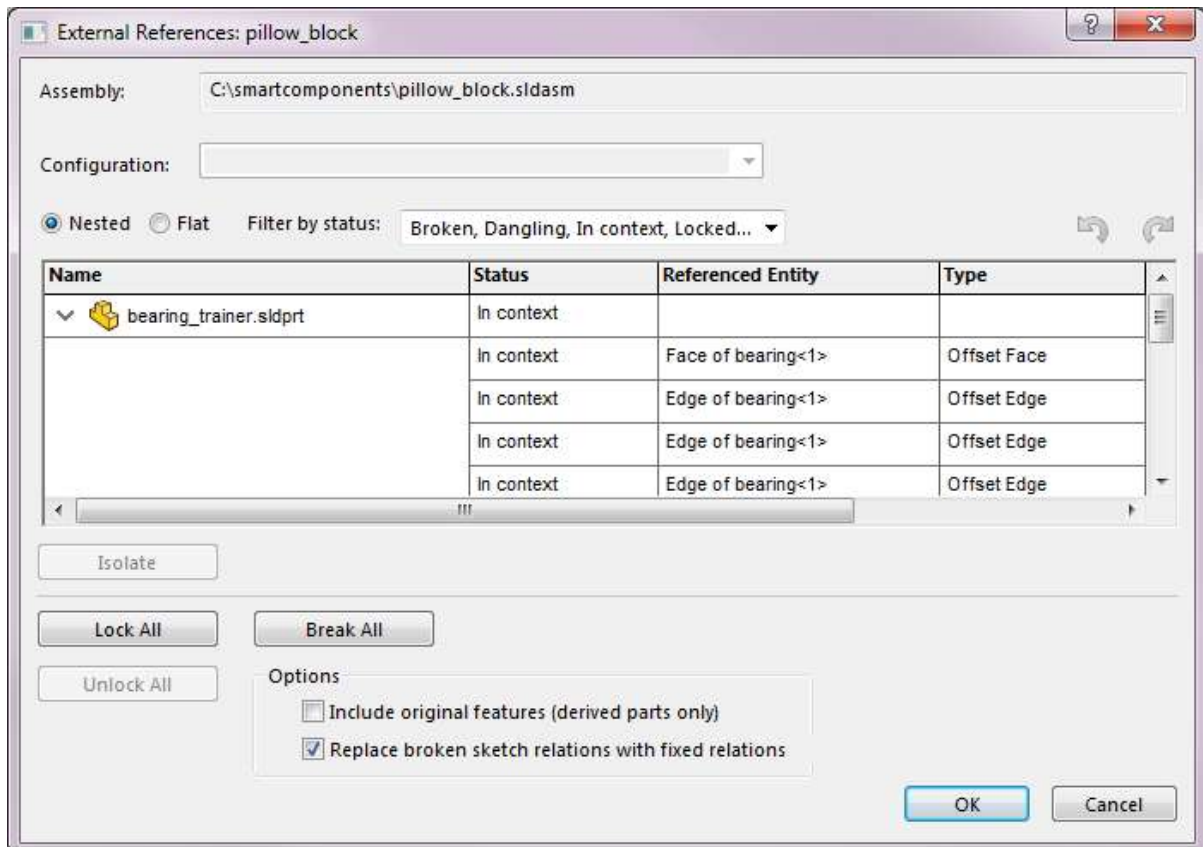

In the FeatureManager design tree, right-click the top-level assembly or a subassembly, and click **External References**.



Functionality in the External References dialog box:

<b>Nested</b>	Lists all components and features with external references hierarchically based on the assembly structure. Components and features are indented. You can expand and collapse nodes.
<b>Flat</b>	Lists all components with external references in a nonhierarchical list.
<b>Expand All</b> <b>Collapse All</b> <b>Clear Selections</b>	Right-click in the table section of the dialog box to use these tools. <b>Expand All</b> and <b>Collapse All</b> are available when you select <b>Nested</b> .

---

<b>Filter by status</b>	Filters the components and features with the following statuses: <ul style="list-style-type: none"><li>• <b>Broken</b></li><li>• <b>Dangling</b></li><li>• <b>In context</b></li><li>• <b>Locked</b></li><li>• <b>Out of context</b></li></ul>
<b>Undo</b> 	Reverses a change made in the dialog box. When you select <b>Include original features (derived parts only)</b> , you cannot undo a break operation.
<b>Redo</b> 	Reverses <b>Undo</b>  in the dialog box.
<b>Isolate</b>	Isolates components from the selected external reference. Available when the active document is an assembly and you select one or more components.
<b>Lock Selected</b>	Locks external references for selected features and sketches. If you lock external references for a feature or sketch, you can create external references to the component. If you lock external references for a component, all external references in the component are locked and you cannot create external references to that component.  Equations that have an external reference are not affected by a lock.
<b>Unlock Selected</b>	Unlocks external references for selected features and sketches.
<b>Break Selected</b>	Breaks external references for selected features and sketches. If you break external references for a component, all external references in the component are broken. When you select <b>Include original features (derived parts only)</b> , you cannot undo a break operation.  Equations that have an external reference are not affected by a break.

---

When you select a referenced entity, the entity along with the other entities that reference it are highlighted in the FeatureManager design tree and in the graphics area. The selected entity is highlighted using the **Selected Item 1** color. The corresponding reference entities are highlighted using the **Selected Item 3** color.

Renamed tools and options:

- **List External Refs** is renamed to **External References**.
- **Insert the feature(s) of original parts if references are broken** is renamed to **Include original features (derived parts only)**.

- **List Broken References** is replaced by **Broken** in **Filter by Status**.
- **Components** and **Feature** columns are renamed to **Name**.
- **Data** is renamed to **Type**.

**External References** is not available for lightweight components. The External References dialog box for a top-level assembly does not list lightweight components.

## FeatureManager Design Tree Conventions for External References

If a feature contains a sketch with external references, the feature displays **{->}** to the right of the feature name in the FeatureManager design tree. A sketch with external references displays **->** to the right of the sketch name.

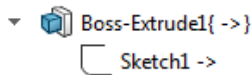

If a feature has an external reference and a sketch with an external reference, the feature displays **->{->}** to the right of the feature name.

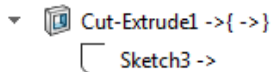



For features that contain sketches with external references in multiple states, all applicable symbols display to the right of the feature name. For example, a feature with a locked external reference and a broken external reference displays **{-> \*x}** to the right of the name.



## Managing External References by using Dynamic Reference Visualization

With **Dynamic Reference Visualization** enabled, you can use the following tools to manage external references:



-  **Break Reference**
-  **Lock Reference**
-  **Unlock Reference**

When you break a reference, the break is permanent. You cannot activate an external reference after it is broken.

When you break a parent reference of a sketch, you are prompted to replace the broken relation with a fixed sketch relation or keep the broken relation.

### To break a reference by using Dynamic Reference Visualization:

1. Open an assembly that has external references.

- In the FeatureManager design tree, right-click the top-level assembly, and click one or both of the **Dynamic Reference Visualization (Parent)**  and **Dynamic Reference Visualization (Child)**  options.
- Select a component that has external references.
- Click the circle and then click **Break Reference** .

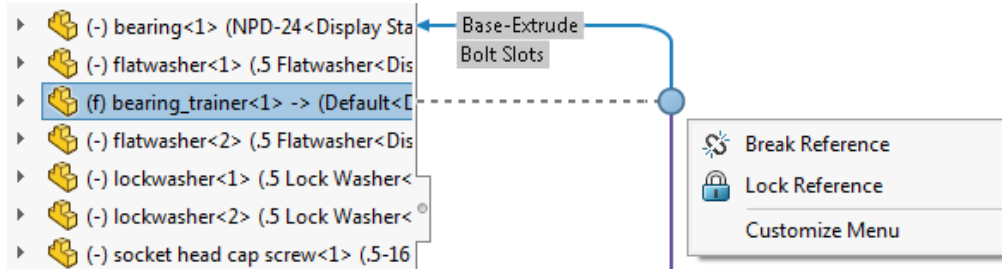

- In the dialog box, review the external reference to break and then click **OK** to break the reference.

## Large Design Review

### Editing Assemblies in Large Design Review

You can use **Edit Assembly** to edit assemblies in Large Design Review mode. You can add and edit mates, and insert components when you edit an assembly.

To use this functionality, open the assembly and component files individually and then save in SOLIDWORKS 2019. Click **File > Save All** to save all the open files at the same time.

In the FeatureManager design tree, the following features appear for top-level assemblies:

- Standard planes
- Origin
- **Mates** folder
- Reference geometry, read-only
- Sketches, read-only
- Component Patterns, read-only

On the **Large Design Review** tab of CommandManager, these tools are available:

- **Insert Components**
- **Mate**

You can use **Move with Triad**. To access this tool, right-click a movable component and click **Move with Triad** .

You cannot insert a component by dragging it from the Task Pane or File Explorer. You cannot copy a component using **CTRL + drag** or **CTRL + C**. You cannot paste a component into the assembly.

You cannot edit an assembly in Large Design Review mode if the top-level assembly contains at least one of these features:

Belt/Chain	Chamfer	Circular Pattern (feature)
Extruded Cut	Fillet	Hole Series
Hole Wizard	Linear Pattern (feature)	Mirror (feature)
Revolved Cut	Simple Hole	Sketch Driven Pattern (feature)
Swept Cut	Table Driven Pattern (feature)	Weld Bead

### To edit assemblies in Large Design Review mode:

1. Click **Open**  (Standard toolbar) or **File > Open**.
2. In the dialog box, select an assembly, and then in **Mode**, select **Large Design Review**.
3. Select **Edit Assembly**.
4. Click **Open**.









An eye overlay  appears on the icons of all components indicating that the assembly is in Large Design Review mode.

To edit an assembly that is open in Large Design Review mode, right-click the top-level assembly, and click **Edit Assembly**.

## Creating Mates in Large Design Review

When you edit assemblies in Large Design Review mode, you can create mates between components and use geometry types as mate references. These mates and mate references are available when you open the assembly in lightweight or resolved mode.

Supported mate types:

 Angle	 Lock
 Coincident	 Parallel
 Concentric	 Perpendicular
 Distance	 Tangent

You can use the following geometry types as mate references for any component in the assembly:



Arc edges	Conical faces	Cylindrical faces
Linear edges	Planar faces	Vertices

## Temporarily Fixed Components

For existing mates or mate references that are not supported in Large Design Review mode, the mates and mate references appear as temporarily fixed .

Flexible subassemblies perform like rigid subassemblies in Large Design Review mode.

## Large Design Review Mark

The name of the **Large Design Review Mark** option is changed to **Display Data Mark**.

## Limitations for Tools in Edit Assembly Mode

Some tools are limited when you edit an assembly that is in Large Design Review mode.

### Insert Component

**Insert Component** adds components as graphics-only in the top-level assembly.

For a top-level assembly that has multiple configurations, **Suppress new components** in the Configuration Properties PropertyManager controls the suppression state of the inserted component.

You cannot add Toolbox components to the assembly.

### Delete

You can delete only top-level components.

### Suppress Components

Available for graphics-only components in the top-level assembly. Components are suppressed only in the active configuration.



### Save and Save As

Use **Save** to save an edited assembly in Large Design Review mode. You cannot use **Save As**.

### Move with Triad

**Move with Triad** is available when you right-click a component and click  to expand the shortcut menu.

## Magnetic Mates in Large Design Review

You can assemble components by using magnetic mates while editing an assembly in Large Design Review mode. Also, you can view the **Ground Plane**  and the **Published Reference**  folders.

You can create, edit, and delete **Ground Plane**  features.

You cannot edit published references in the **Published Reference**  folder and you cannot define new connection points by using **Asset Publisher**.

## Lightweight Mode

### Rebuild Component Patterns

When you edit a feature, you can change the pattern parameters. For a component pattern that is driven by an unavailable entity, **\*\*Lightweight\*\*** shows as a prefix to the entity name. The SOLIDWORKS software rebuilds the pattern in lightweight mode by using the last-used definition.

To use this functionality, save the assembly and the component that contains the driving feature in resolved mode before you open the assembly in lightweight mode.

This rebuild works for the following assembly patterns:

Chain patterns	Circular	Curve Driven
Linear	Pattern Driven	Sketch Driven

This rebuild works for the following derived component patterns:

Advanced Hole Wizard	Advanced Pattern	Circular
Curve	Hole Series	Hole Wizard
Linear pattern	Sketch Pattern	Table Pattern

### Unable to Move or Delete Files in Lightweight Mode

Files opened in lightweight mode are locked and you cannot move or delete them. In Microsoft® File Explorer, you receive a warning message when you delete a file.

#### To move or delete files in lightweight mode:

1. In the SOLIDWORKS software, click **Open**  (Standard toolbar) or **File > Open**.
2. In the dialog box, select the assembly, and then in **Mode**, select **Lightweight**.

3. Click **Open**.
4. Switch to Microsoft File Explorer and delete one of the components.  
You receive a message that the action cannot be completed.

## Mates

### Automatically Lock Rotation for Concentric Mates to Toolbox Components

You can use **Lock rotation of new concentric mates to Toolbox components** to automatically lock rotation for new concentric mates to Toolbox components. You can lock this option in the Settings Administrator Tool.



This option applies when you create concentric mates by:

- Inserting a Toolbox component into another component.
- Creating a SmartMate by using **ALT + drag** on a cylindrical face or a circular edge of a Toolbox component that is in the assembly.
- Using the Smart Fasteners tool.
- Defining Smart Fasteners in a new Hole Series.
- Manually creating a concentric mate to a Toolbox component.

When you clear this option, you can select **Lock Concentric Rotation** for the **Mates**  folder or **Lock Rotation** for each unlocked concentric mate.

#### To enable automatic lock rotation for concentric mates:

1. Click **Tools > Options > System Options > Hole Wizard/Toolbox**.
2. Under **Toolbox Mates**, select **Lock rotation of new concentric mates to Toolbox components**.

The  icon indicates locked concentric mates. The  icon indicates unlocked concentric mates.

### Disabling Automatic Mate Updates in Toolbox

You can temporarily disable the automatic update of mates between a Toolbox component and a non-Toolbox component by clearing **Automatic Update for Toolbox Mates**. By disabling the automatic update, you can improve performance by making it quicker to edit mates, add mates, and manipulate components.

When you disable automatic mate updates:

- Toolbox fasteners do not move if you move the components to which they are mated. Non-Toolbox components do move.
- Performance improves when working in assemblies with several Toolbox components inserted and mated at the top level. For example, in assemblies with hundreds of fastener stacks at the top level, updating these mates can impact assembly performance when performing actions like solving mates, adding mates, and dragging components.

Performance improvements do not occur when Toolbox components are:

- In subassemblies because the option affects solving mates at the top level only.
- Patterned, because patterned instances do not use mates.

You must disable **Automatic Update for Toolbox Mates** each time you open an assembly.





#### To disable automatic mate updates:

In an assembly with Toolbox components, in the FeatureManager design tree, right-click the **Mates**  folder and clear **Automatic Update for Toolbox Mates**.

The **Mates** folder and the mates inside it appear with this icon: .

#### To update the mates:

In the FeatureManager design tree, right-click one of the following and click **Automatic Update for Toolbox Mates**:



- **Mates**  folder
- **Fasteners** subfolder in the **Mates**  folder 
- Individual mates in the **Mates**  folder

All mates in the assembly are updated.

## Grouping Mates and Separating Fasteners

You can group mates by status and separate fasteners into folders.

**By Status** groups mates by the following statuses:

Folder Name	Description
<b>Solved</b>	Mates that are solved without errors.
 <b>Errors</b>	Mates with mate errors.
 <b>Over Defined</b>	Mates with over defined warnings.
<b>Suppressed</b>	Mates that you suppressed.
<b>Suppressed (Missing)</b>	Suppressed mates that reference missing components.
<b>Inactive (Fixed)</b>	Inactive mates that reference fixed components.

The status folders  appear in the **Mates**  folder.

**Separate Fasteners** separates mates that reference a Toolbox component into a

**Fasteners**  folder. The **Fasteners** folder includes suppressed mates that reference a Toolbox component. If you edit a mate to include a Toolbox component, the mate moves to the **Fasteners** folder after you save the changes.

If you select **By Status** and **Separate Fasteners**, the **Fasteners** folders are nested under the status folders.

The status and fastener folders automatically update when you change the assembly. The number of mates contained in each folder displays to the right of the folder name. If you select both grouping options, the number for the status folder includes the number for the **Fasteners** subfolder.

Grouping mates does not modify the solve order for mates. You cannot move mates to different status or fastener folders.

**Add to New Folder** is not available for mates in the status or fastener folders. To create a folder, you must clear **By Status** and **Separate Fasteners**. For mates in user-created mate folders, the mates move to the appropriate grouping folder when you group by status or separate fasteners. When you clear these grouping options, the mates return to their original mate folders. If you delete a user-created mate folder while a grouping option is selected, the mates from the deleted mate folder move to a folder that is up one level.

#### To group mates and separate fasteners:







1. In the FeatureManager design tree of an assembly, right-click **Mates**  and click **Group Mates**.
2. Click **By Status** to sort mates by status.
3. Click **Separate Fasteners** to show fasteners in separate folders.

## Negative Values for LimitAngle Mates in Mate Controller







You can use negative angle values in Mate Controller and Animation for **LimitAngle**  mates.



### Mate Controller

#### To use negative values for LimitAngle mates in Mate Controller:

1. Open an assembly that contains a **LimitAngle**  mate.
2. Click **Insert** > **Mate Controller** .
3. In the PropertyManager, click **Collect All Supported Mates** .
4. In **Collect All Supported Mates**, select a **LimitAngle**  mate.
5. For **Position 1** , enter a dimension for the **LimitAngle**  mate and click **Update Position** .



For example, enter 100 for dimension.

6. Under **Mates Positions**, click **Add Position** .
7. For **Position 2** , enter 0 for the dimension and click **Update Position** .
8. Under **Mates Positions**, click **Add Position** .
9. For **Position 3** , enter -100 for the dimension and click **Update Position** .

10. Optional: Expand **Animation** and click **Calculate**  to view the animation.
11. Click .

## Animation

### To view the animation that you created in Mate Controller:

1. Click the **Motion Study 1** tab.
2. For **Type of Study**, select **Animation**.
3. Click **Animation Wizard**  (MotionManager toolbar).
4. In the dialog box, select **Mate Controller**.
5. Specify options in the dialog box.
6. Click **Calculate** .



# Patterns

## Circular Patterns

You can include a second direction with the option to make the spacing and instance count symmetric to the first pattern direction.

### To specify a second direction for circular patterns:

1. In an assembly, click **Linear Component Pattern** > **Circular Component Pattern**  (Assembly toolbar) or **Insert** > **Component Pattern** > **Circular Pattern**.
2. In the PropertyManager, specify options for **Direction 2**:

<b>Direction 2</b>	Enables <b>Direction 2</b> options.
<b>Symmetric</b>	Creates a symmetrical pattern from the seed feature.
<b>Equal Spacing</b>	Sets <b>Angle</b>  to 360°.
 <b>Angle</b>	Specifies the angle between each instance.
 <b>Number of instances</b>	Specifies the number of instances of the seed feature.

## Including Custom Properties in a Mirrored Assembly

You can include custom properties when you create an opposite-hand mirror assembly or subassembly. Custom properties include global properties and configuration-specific properties.

A link is established between the mirrored assembly and the original assembly. Changes to the custom properties in the original assembly are included in the mirrored assembly. You cannot edit custom properties in the mirrored assembly.

### To include custom properties in a mirrored assembly:

1. Open an assembly that has a custom property.
2. Click **Mirror Components**  (Assembly toolbar) or **Insert > Mirror Components**.
3. In the PropertyManager, create a mirror pattern.

Click **Create opposite hand version** in **Step 2: Set Orientation** to continue through the PropertyManager.

4. In **Step 4: Import Features**, under **Transfer**, select **Custom Properties**.

If you select **Break link to original part** under **Link**, changes made in the original assembly are not included in the mirrored assembly.

5. Click  to create the mirrored component.



## Linear Patterns

You can pattern components up to a selected reference. You can specify options for spacing or the number of instances.

For **Direction 1**, clear **Fixed axis of rotation** to specify the rotation axis in any direction. When you select this option, you can rotate patterned instances around a common axis, which is the same behavior as the previous SOLIDWORKS release.



In the Linear Pattern PropertyManager, specify the following options for spacing or the number of instances for **Direction 1** and **Direction 2**:

---

<b>Spacing and instances</b>	Independently specifies the spacing and the number of instances.	
 <b>Spacing</b>		Defines the spacing between pattern instances.
 <b>Number of Instances</b>		Defines the number of pattern instances. This number includes the original features or selections.

---

---

<b>Up to reference</b>	Specifies the spacing and the number of instances based on the selected reference geometry.
 <b>Reference Geometry</b>	Specifies the reference geometry that controls the pattern.
 <b>Reverse offset direction</b>	Reverses the direction that the pattern is offset from the reference geometry.
<b>Offset distance</b>	Specifies the distance of the last pattern instance from the reference geometry.
<b>Component Centroid</b>	Calculates the offset distance from the reference geometry to the centroid of the patterned feature.
<b>Selected reference</b>	Calculates the offset distance from the reference geometry to a selected seed feature geometry reference.
 <b>Reference Geometry</b>	Specifies which seed feature geometry to calculate the offset distance from.

---

**Fixed axis of rotation** **Direction 1** option. Patterned instances rotate around a common axis.

Available when you select **Rotate instances**.

When cleared, the rotation axis for each instance of a component is translated along **Direction 1** and then rotated following the axis of rotation for that component.

---

## Performance Evaluation

In the Performance Evaluation report, you can click **Open**  to open a file in a new window from the **Details of the Open Document File** and **Graphics Triangles** sections. You must close the Performance Evaluation dialog box before you can switch to the opened file.

For the **Open Time** and **Total Triangles** columns, the values are overlaid on the bar for each row.

Component and configuration names are not truncated. For names that do not display completely, an ellipse appears at the end of their name.

In **Assembly Rebuild Report**, you can expand or collapse nodes. Components that are rebuilt more than one time appear in red. Components that take 10 milliseconds or less to rebuild are omitted from the list.

To run **Performance Evaluation** for an open assembly, click **Performance Evaluation**  (Assembly toolbar) or **Tools > Evaluate > Performance Evaluation**.



## Saving an Assembly as a Part

When saving an assembly as a part, you can include or remove components based on specified criteria to simplify the saved part.

You can use the following criteria to save an assembly as a simplified part:

- Visibility of the component from outside the model.
- Size (volume) of the component.
- If the component is a Toolbox component.

You can specify a component property to include or exclude the component when saving an assembly as a part.

### To open the Component Properties dialog box:

1. In an assembly document, right-click a component and click **Component Properties** .
2. In the dialog box, under **Save assembly as part**, select an option:

---

**Use system settings** Uses the System Options to include or exclude a component.

---

**Always include** Includes a component in the resulting part when saving an assembly as a part.  
This option overrides conditions that are defined in the System Options and the Save Assembly as Part PropertyManager.

---

**Always exclude** Excludes a component in the resulting part when saving an assembly as a part.

---

## Assemblies Saved as Parts Export Options

### To specify the export options:

1. Click **Tools > Options > System Options > Export**.
2. For **File Format**, select **SLDPRT from assembly**.
3. Specify the following options, and click **OK**.

## Specified components

<b>Remove</b>	<b>Visibility threshold (internal components)</b>	Removes components that are below the visibility threshold. Move the slider to the right to decrease the threshold for the internal components to be visible.
	<b>Bounding box volume less than</b>	Removes components that are below the volume threshold.  This bounding box is a cuboid that aligns to the component origin and fits around the geometry of the component. This bounding box is different from a bounding box created by the Bounding Box PropertyManager.
	<b>Fastener Components</b>	Removes components that have the <b>IsFastener</b> property specified as 1.
<b>Include</b>	<b>Mass properties</b>	Overrides the mass properties of the part with the mass properties from the assembly.

## Save Assembly as Part PropertyManager

### To open the Save Assembly as Part PropertyManager:

1. In an assembly, click **File > Save As**.
2. Select **Part (\*.prt;\*.sldprt)** for the file type.
3. Select **Include specified components**.
4. Select **Override defaults**.
5. Click **Save**.

Specify the following options in the PropertyManager:

### Remove Components

<b>Visibility threshold (internal components)</b>	Removes components that are below the visibility threshold. Move the slider to the right to increase the threshold for the internal component to be visible.
---	---

---

<b>Bounding box volume less than</b>	Removes components that are below the volume threshold. This bounding box is a cuboid that aligns to the component origin and fits around the geometry of the component. This bounding box is different from a bounding box created by the Bounding Box PropertyManager.
--------------------------------------	---

---

<b>Fastener components</b>	Removes components that have the <b>IsFastener</b> property set to 1.
----------------------------	---

---

<b>Display</b>	Controls the display of components. Select an option:
<b>Display All</b>	Shows all components.
<b>Display Included Components</b>	Shows included components.
<b>Display Removed Components</b>	Shows removed components.

---

## Include

---

<b>Mass Properties</b>	Overrides the mass properties of the part with the mass properties from the assembly.
------------------------	---

---

## Results

---

<b>Use these settings in System Options</b>	Applies the selections made in this PropertyManager to the System Options. This option is not available if the Systems Options are locked by an administrator.
---	---

---

<b>Reset</b>	Restores the PropertyManager default options.
--------------	---

---

# Select Identical Components

You can use **Select Identical Components** tool with the following options:

Option	PropertyManager
<b>Components to Pattern</b>	Circular Component Curve Driven Component Linear Component Pattern Driven Component Sketch Driven Component
<b>Components to Mirror</b>	Mirror Components
<b>These components</b> Available when you select <b>Collision Detection</b> or <b>Physical Dynamics</b> .	Move Component Rotate Component
<b>All components</b> in the <b>Feature Scope</b> section	Extruded Cut Hole Series Hole Wizard Revolved Cut Simple Hole Swept Cut
<b>Component Selection</b>	Defeature Exploded View

Access **Select Identical Component** by right-clicking:

- A component in the graphics area.
- A selected component in a PropertyManager.
- A component in the flyout FeatureManager design tree.

# Treehouse

## Create Custom and Configuration-specific Properties in Treehouse

You can add custom and configuration-specific properties to a Treehouse node. This functionality is identical to the functionality available in the SOLIDWORKS software.

### Custom Properties

#### To create custom properties:

1. In Treehouse, right-click a node and click **Properties** .
2. In the dialog box, click the Custom tab.

If you select more than one node, you see **Multiple Values** as the value in the **Value / Text Expression** and **Evaluated Value** columns when there is more than one value for these fields.

3. For new nodes or for nodes that you created by using **Saved as New Document**, enter values for **File Name** and **File Location**.

You cannot change **File Name** and **File Location** for existing nodes.

4. Populate the following columns:

<b>Property Name</b>	Enter or select a value.
<b>Type</b>	Select a value.
<b>Value / Text Expression</b>	Enter or select a value.
<b>Evaluated Value</b>	Calculated value based on <b>Value / Text Expression</b> .

5. Optional: To link the property value for a part to the BOM quantity, select the property from **BOM quantity**.
6. Optional: To add, delete, or move a property up or down in the list, click **Edit List**.
7. Optional: To delete a property, select the row to the left of **Property Name** and click **Delete**.
8. Click **OK**.

### Configuration-Specific Properties

You cannot add configuration-specific properties if you select two or more nodes.

#### To create configuration-specific properties:

1. In Treehouse, right-click a node and click **Properties** .
2. In the dialog box, click the Configuration Specific tab.

If you select more than one node, the Configuration Specific tab is not available.

3. For new nodes or for nodes that you created by using **Saved as New Document**, enter values for **File Name** and **File Location**.



You cannot change **File Name** and **File Location** for existing nodes.

4. To add the property to a configuration, select the configuration from **Apply To**.
5. Populate the following columns:

<b>Property Name</b>	Enter or select a value.
<b>Type</b>	Select a value.
<b>Value / Text Expression</b>	Enter or select a value.
<b>Evaluated Value</b>	Calculated value based on <b>Value / Text Expression</b> .

6. Optional: To link the property value for a part to the BOM quantity, select the property from **BOM quantity**.
7. Optional: To add, delete, or move a property up or down in the list, click **Edit List**.
8. Optional: To delete a property, select the row to the left of **Property Name** and click **Delete**.
9. Click **OK**.

## Display in a List View

You can access the Properties dialog box in the Display in a List view  by selecting a row and then clicking **Show Document Properties** .

In the Display in a List view  dialog box, column titles for configuration-specific properties appear in blue. Properties with a white background are associated with the selected file. Properties with a gray background are not associated with the selected file.

To specify the file path for new documents, click **Browse** and select a folder for the **Default Destination**. After selecting a folder, click **Apply**.

## Select Multiple Files for Import

You can select multiple part and assembly files to add to an existing assembly file in the Treehouse graphics area.

### To import multiple files:

1. In Treehouse, open an existing assembly file.



2. Click **Existing File** and select multiple files in one of the following ways:
  - **Ctrl + select** to select individual files.
  - **Shift + select** to select a group of files.

If you select files that are not part (.sldprt) or assembly (.sldasm) files, a message warns that you cannot import these files.

3. Drag the selected files to the assembly in the graphics area.

## Treehouse Graphics Area Enhancements

- Node size increased horizontally.
- Links for the Configuration dialog box and the Properties dialog box moved to the top of the node.
- Subassemblies display in a more vertical format.

## Treehouse Options

### File Extensions

You can use **Display file extensions** to display file extensions in the list view and the node view. This option is selected by default. Clearing this option allows more space to show the document name.

#### To clear **Display file extensions**:

1. In Treehouse, open an assembly.



2. Click Treehouse Options.
3. In the dialog box, under View, clear **Display file extensions**.

**Display file extensions** applies when you select **Use the File name** under **Name to Display**.

4. Click **Apply** and then click **OK**.

### File Images on Nodes

You can use **Display file images on the nodes** to display images on the nodes. This option is selected by default. Clearing this option allows more space to show the document name.

#### To clear **Display file images on the nodes**:

1. In Treehouse, open an assembly.



2. Click Treehouse Options
3. In the dialog box, under View, clear **Display file images on the nodes**.
4. Click **Apply** and then click **OK**.

## Include Images in Microsoft Excel

You can view file images in Microsoft® Excel®.

### To include file images:

1. In Treehouse, open an assembly.



2. Click Treehouse Options
3. In the **Options** dialog box, under View, select **Include file images when saving to Excel**.
4. Click **Apply** and then click **OK**.
5. Click **Open in Excel** .
6. In the **Open in Excel** dialog box, select **Open Structure** or **Open Parts Only**, and click **OK**.

In the spreadsheet, file images appear in the first column.

## Use Custom Property for Document Name in Treehouse

You can display a custom property as the document name.

### To select a custom property for the document name:

1. In Treehouse, open an assembly.



2. Click Treehouse Options
3. In the dialog box, under **Name to Display**, select **Use the Custom Property named** and then select a property.
4. Click **Apply** and then click **OK**.

The property displays on the nodes. The document name appears blank for files that do not have a value for the property.



## Warning When Inserting Complex Components

When you insert a part into an assembly, you are warned when the SOLIDWORKS software detects a high number of faces or graphics triangles in the part. A high number of faces or graphics triangles indicates a high level of detail.

The warning does not prevent you from inserting the component. The warning includes a link to the **Performance Evaluation** tool for further analysis.

The warning appears when an inserted part meets one of the following conditions:

- Over 3,500 faces and over 150,000 graphics triangles
- Over 300,000 graphics triangles

# 7

## SOLIDWORKS CAM

---

This chapter includes the following topics:

- **Assign Default Strategies to Machine Types**
- **CNC Compensation for Curve Features**
- **Corner Slowdown and Arc Feed Rate**
- **Improved Chamfer Machining**
- **Improved Toolpath Editing**
- **Improvements to Tolerance-based Machining**
- **More Parameters for Tapered Shanks and Support for Barrel Tool Type**

SOLIDWORKS CAM is offered in two versions. SOLIDWORKS CAM Standard is included with any SOLIDWORKS license that has SOLIDWORKS Subscription Service.

SOLIDWORKS CAM Professional is available as a separately purchased product that you can use with SOLIDWORKS Standard, SOLIDWORKS Professional, and SOLIDWORKS Premium.

### Assign Default Strategies to Machine Types

You can create schemes of default feature strategies and assign them to machine types.

### CNC Compensation for Curve Features

CNC compensation is extended to curve features.

### Corner Slowdown and Arc Feed Rate

To allow different feed rates for arcs, machining slows down when approaching sharp corners. Arc feed rates are calculated based on the radiuses.

### Improved Chamfer Machining

In the Mill Features tab, you can apply chamfers to curve features. The software automatically recognizes chamfers. You can create additional chamfer operations with the **Curve [edge break] Feature**.

Ball end cutters are also supported.

## Improved Toolpath Editing

Toolpath editing provides better performance and an improved interface.

## Improvements to Tolerance-based Machining

When machining a feature, you can move the feature manually based on the tolerance. The software also calculates the delta based on the tolerances.

The software provides additional options for recognizing a tolerance range, ISO286 limits, and fits for turning.

## More Parameters for Tapered Shanks and Support for Barrel Tool Type

You can specify more parameters to tapered shanks. The parameters give you more control over tapered shanks and make it easier to connect to the Tools catalog.

Barrel tools are available as a tool type.

# 8

## CircuitWorks

---

This chapter includes the following topics:

- **Recognizing Additional SOLIDWORKS Features in CircuitWorks**

CircuitWorks is available in SOLIDWORKS Professional and SOLIDWORKS Premium.

### Recognizing Additional SOLIDWORKS Features in CircuitWorks

When you export SOLIDWORKS board files to CircuitWorks™ using the CircuitWorks Export Wizard, the wizard recognizes and translates some SOLIDWORKS features into CircuitWorks terms.

Features	Supported Seed Features
<b>Table Driven Pattern</b>	<b>Extruded Cut, Hole Wizard, Simple hole</b>
<b>Mirror patterns</b>	<b>Extruded Cut, Hole Wizard, Simple hole</b>
	<b>Linear Pattern, Circular Pattern, Sketch Driven Pattern, and Curve Driven Pattern</b>
<b>Slot</b>	Simple slots in <b>Hole Wizard</b>

The wizard recognizes simple slots in **Hole Wizard** features and all sketch slots from extruded cuts.

In the **CircuitWorks Export Wizard**, when you select **Use the Silhouette Edges**, support for defining slots as NPTH and PTH is unavailable.

# 9

## SOLIDWORKS Composer

---

This chapter includes the following topics:

- **SOLIDWORKS Composer**
- **SOLIDWORKS Composer Sync**

### SOLIDWORKS Composer

SOLIDWORKS® Composer™ software streamlines the creation of 2D and 3D graphical contents for product communication and technical illustrations.

### Animation Library Workshop and Timeline Enhancements

The Animation Library Workshop and the timeline behave more intuitively.

- You can create camera keys in animation blocks. This helps define the behavior of the camera throughout the step. The **Auto Centering** mode, for example, ensures that the entire motion remains visible throughout the step. See *Composer Help: Animation Library Workshop > Properties*.
- When there is empty space between two existing animation steps, the application automatically creates an empty space. Contextual options and user interface improvements let you manage empty spaces on the timeline more intuitively and efficiently. See *Composer Help: Creating Pre-defined Animations*.
- In the Animation Library, if you delete an actor from the model, the application deletes the corresponding animation keys from the timeline. When this leaves an animation block empty (devoid of actors), a message informs you that the animation block is no longer associated with any actor, and prompts you to delete the animation block from the timeline. See *Composer Help: Creating Pre-defined Animations > Creating a Simple Animation*.
- In the Animation Library workshop:
  - The **Animations** area is renamed to **Templates**. The behavior of the drop-down boxes in the **Templates** area has improved. When you select several motions in the timeline, the application empties the drop-down boxes.
  - You can update animation blocks using the **Update Selection** command in the **Animations** area. Previously, to update actors in an animation block, you had to delete the animation block and recreate it with the updated set of actors.

The **Update Motion** command updates the properties of animation blocks selected in the timeline.

See *Composer Help: Animation Library Workshop*.

## Defining Custom Import Profiles

You can define profiles with custom import options to use when importing CAD data.

Import profiles are defined in XML file format.

See *Composer Help: Defining Custom Import Profiles*.

## Importing Assembly Envelopes Option

When you open a SOLIDWORKS assembly that contains envelopes, you have the option to import the envelopes. Previously, Composer always imported assembly envelopes.

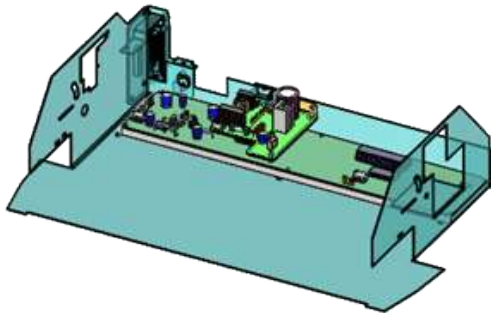

In the Open dialog box, select **Import SOLIDWORKS assembly envelopes** to import this data. This option is available for the **Open**, **Merge into the current document**, and **Merge into a new document** options. This option is selected by default.

You can enable this functionality from the SOLIDWORKS software. Click **Tools > Options > System Options > Export > SMG** and select **Export SOLIDWORKS assembly envelope**.

You can also batch import assembly envelopes using SOLIDWORKS Composer Sync. In the Sync Document Properties dialog box, click **Advanced Properties**. Under **INPUT - IMPORT**, select **Batch.IOSSWImportAsmbyEnvelopes**.

See *Composer Help: Input*.

## Importing PMI Data

SOLIDWORKS Composer can import Product Manufacturing Information (PMI) data from SOLIDWORKS models.

To import PMI data, in the **Open** dialog box, click **Import** and select **Import PMI**.

Composer can import:

- Dimensions
- Datums
- Tolerances for dimensions
- Geometric tolerances

- Special symbols such as diameters and degrees
- Surface finishes

To modify the PMI colors during import, select **Overwrite color** and choose a color, which is applied to all the imported PMI data.

Composer stores the PMI data in the **PMI Data (SOLIDWORKS)** folder under a root node on the Assembly tab. Select or clear check boxes to hide or show the PMI data.

Composer imports view-based data such as annotation views from SOLIDWORKS and 3D views from SOLIDWORKS MBD. Composer stores these views in the **PMI Views (SOLIDWORKS)** folder under a root node on the Assembly tab in Composer. The **3D Views** and **Annotation Views** subfolders contain these categories of imported views.

After you import the PMI data into a .smg file, the PMI data is visible in Composer Player. Composer Sync also imports PMI data from SOLIDWORKS models into .smg files.

To enable this functionality from the SOLIDWORKS software, click **Tools > Options > System Options > Export > SMG** and select **Export PMI**.

See *Composer Help: Input*.

## Markup Properties

You can control linear arrows with **Fixed Size Arrow** and **Fixed Length** in the **Properties** pane for markups.

**Fixed Size Arrow** → ensures that a linear arrow always remains visible by specifying that its size must remain fixed, regardless of the zoom factor. **Fixed Length** → specifies the required length of the fixed size arrow.

See *Composer Help: Markup Properties*.

## Measurement Properties

You can use additional properties in the **Properties** pane to manage the display of measurements:

- The **General** section contains the **Show planes** property. It also contains two updated properties, **Show red lines** and **Show Axis Vertices**, which are also available for distance between centers, and for distance between two axes. The **Show Construction Lines** property displays all construction lines in measurements.
- In the **Label** section, the **Shape** property contains the **Rounded Rectangle**  value.
- The **Attach** section contains the **Show end points**, **End point size**, and **End point color** properties.

See *Composer Help: Measurement Properties*.

## Number of Selected Actors Appears in the Status Bar

The status bar displays the number of selected actors. If no actor is selected, it displays the total number of actors in the model.

Click this number on the status bar to display the statistics for the current selection or for the current model.

See *Composer Help: Status Bar*.

## Search for Collaborative Actors

You can search for collaborative actors using the **Include** command in the **Search** pane (accessed from the **Assembly** pane) or from the **Collaboration** pane.

Previously, only geometry actors were taken into account when searching for actors from these panes.

See *Composer Help: Search Pane*.

## Search for Commands in the Ribbon

The **Search** command is available on the ribbon. Previously, it was located in the **File** menu.

You can directly access **Search** to search for commands in the ribbon and recently used documents.

See *Composer Help: Working with the Ribbon > Search for Commands in the Ribbon*.

## Select Adjacent Parts

You can use the **Select Adjacent Parts** command, under **Navigate** in the **Home** ribbon, to select all parts that contact or intersect the selected part.

This command is available when you select at least one part (geometry actor).

See *Composer Help: Home Tab > Navigate Commands*.

## SOLIDWORKS PDM Integration

You can use the integrated **SOLIDWORKS PDM** ribbon tab to perform vault commands and view file information when the file is open in Composer. You must have SOLIDWORKS PDM Professional installed.

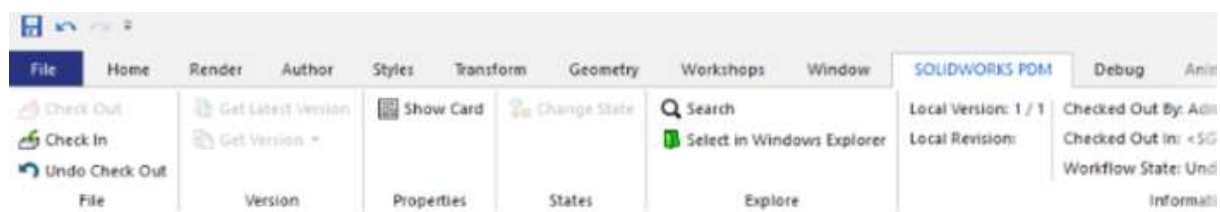

You can access these SOLIDWORKS PDM functions from Composer:



- **Change State**
- **Check In, Check Out, Undo Check Out**
- **Get Latest Version, Get Version**
- **Search** and **Select in Windows Explorer**
- **Show Card**
- **Information** section. Displays details about the **Local Version, Local Revision, Checked Out By, Checked Out In,** and **Workflow State.**

If no file is open in Composer, only **Search** is available. If you open a file that is saved outside the PDM vault, **Search** and **Select in Windows Explorer** are available. Once you save an active Composer file in the PDM vault, the other PDM commands are available.

See *Composer Help: SOLIDWORKS PDM Tab* and *SOLIDWORKS PDM Help: SOLIDWORKS PDM Ribbon*.

## Undefined Color Properties in Animation Library

You can specify the color parameter of the predefined **Flash** and **SetColor** motions properties to **Undefined**.

This parameter lets you avoid changing the color of the selected actor during this step of the animation.

See *Composer Help: Animation Library Workshop* and *Composer Help: Custom Animation XML Example*.

## User Experience Enhancements for SOLIDWORKS Composer

- The user interface has new command icons, particularly in the ribbon.
- New samples and 3D tools (arc welding gun, bearing puller, drill, and oil) are in the Composer `<install_dir>\Samples` folder. You can access samples and 3D tools through the Model Browser Workshop.



See *Composer Help: Model Browser Workshop*.

- The user interface has been translated in five more languages: Czech, Polish, Portuguese (Brazilian), Spanish, and Turkish.

The documentation is not translated in these languages.

See *Composer Help: General*.

## Versioning of Backup Files

When you use the **AutoSave** advanced setting, which automatically backs up the open Composer files, you can use the **AutoSaveVersioning** setting to create versions of the backup versions.

Use the **AutoSaveVersioningMaxNumberOfFiles** setting to specify the maximum number of backup files to keep.

See *Composer Help: Advanced Settings*.

## Working with Views

You can lock and unlock views.

Locked views  prevent you from updating them by mistake.

See *Composer Help: Working with Views > Lock a View*.

## SOLIDWORKS Composer Sync

### Conversion Properties - Occlusion Options

You can configure occlusion options to use when importing native CAD files.

Occlusion removes parts from the model based on size or whether the parts are internal and therefore not visible.

See *Composer Help: Repair/Refinement > Occlusion*.



Occlusion options are also available through the command-line interface.

See the *Composer Programming Guide* for more information.

## Importing Assembly Envelopes Option

When you open a SOLIDWORKS assembly that contains envelopes, you have the option to import the envelopes. Previously, Composer always imported assembly envelopes.

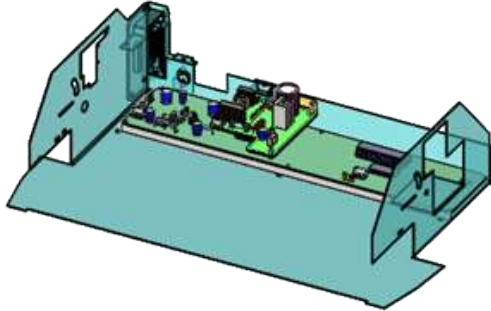

In the Open dialog box, select **Import SOLIDWORKS assembly envelopes** to import this data. This option is available for the **Open**, **Merge into the current document**, and **Merge into a new document** options. This option is selected by default.

You can enable this functionality from the SOLIDWORKS software. Click **Tools > Options > System Options > Export > SMG** and select **Export SOLIDWORKS assembly envelope**.

You can also batch import assembly envelopes using SOLIDWORKS Composer Sync. In the Sync Document Properties dialog box, click **Advanced Properties**. Under **INPUT - IMPORT**, select **Batch.IOSSWImportAssmbyEnvelopes**.

See *Composer Help: Input*.

## Importing PMI Data

SOLIDWORKS Composer can import Product Manufacturing Information (PMI) data from SOLIDWORKS models.

To import PMI data, in the **Open** dialog box, click **Import** and select **Import PMI**.

Composer can import:

- Dimensions
- Datums
- Tolerances for dimensions
- Geometric tolerances
- Special symbols such as diameters and degrees
- Surface finishes

To modify the PMI colors during import, select **Overwrite color** and choose a color, which is applied to all the imported PMI data.

Composer stores the PMI data in the **PMI Data (SOLIDWORKS)** folder under a root node on the Assembly tab. Select or clear check boxes to hide or show the PMI data.

Composer imports view-based data such as annotation views from SOLIDWORKS and 3D views from SOLIDWORKS MBD. Composer stores these views in the **PMI Views (SOLIDWORKS)** folder under a root node on the Assembly tab in Composer. The **3D Views** and **Annotation Views** subfolders contain these categories of imported views.

After you import the PMI data into a .smg file, the PMI data is visible in Composer Player. Composer Sync also imports PMI data from SOLIDWORKS models into .smg files.

To enable this functionality from the SOLIDWORKS software, click **Tools > Options > System Options > Export > SMG** and select **Export PMI**.

See *Composer Help: Input*.

## Remove Empty Groups After Occlusion

You can use the **IORemoveEmptyGroupsAfterOcclusion** advanced property to remove empty groups at import.

This advanced property removes empty groups from the assembly tree if empty groups exist as a result of the occlusion process at import. This option is selected by default.

See *Composer Help: Advanced Properties*.

# 10

## DimXpert

---

This chapter includes the following topics:

- **Copying DimXpert Schemes to Derived Parts**
- **DimXpert Features**
- **DimXpert for Assemblies**
- **MBD Dimension**

### Copying DimXpert Schemes to Derived Parts

When you create a derived part, you can include DimXpert annotations and features from the original part by selecting **DimXpert scheme** in the Insert Part PropertyManager.

### DimXpert Features

You can define torus and surface of revolution features in DimXpert.

### DimXpert for Assemblies

DimXpert tools within assembly documents are available in core SOLIDWORKS and no longer require SOLIDWORKS MBD.

### MBD Dimension

The DimXpert CommandManager and toolbars in part and assembly documents are now named MBD Dimension.

# 11

## Detailing and Drawings

---

This chapter includes the following topics:

- **Automatic View Updates and Exclusions**
- **Configuring the Precision of Dimensions and Tolerances**
- **Displaying Scrollbars**
- **Drawing Open Progress Indicator**
- **ISO Tolerance-Modifying Symbols**
- **Performance Improvements - Detailing and Drawings**
- **Removed Section Views**
- **Tables**

## Automatic View Updates and Exclusions

### Automatic View Updates

The **Automatic view update** option, which controls whether views are updated when the model changes, is now a document property that is saved within the drawing.

To change the update option in the current drawing, right-click the icon at the top of the FeatureManager design tree and select or clear **Automatic view update**. When you save the drawing, the option is saved within the drawing and remembered from one session to the next. Previously, it applied only in the current session.

### Excluding Drawing Views from Automatic Updates

You can exclude selected views from automatic updates that occur when the model changes.

In the Drawing View PropertyManager, under **Automatic View Update**, select **Exclude from automatic update**.

# Configuring the Precision of Dimensions and Tolerances

In the Dimension PropertyManager, you can configure the precision of dimensions and tolerances. In design tables, you can configure the precision of tolerances.

**To configure precision of dimensions and tolerances:**

1. In the Dimension PropertyManager, under **Tolerance/Precision**, specify a tolerance type and maximum and minimum variations.
2. For **Unit Precision**, specify the number of decimal places for the dimension value.
3. For **Tolerance Precision**, specify the number of decimal places for the tolerance value.
4. Click **Configurations**.
5. In the dialog box, select **This configuration**, **All configurations**, or **Specify configurations**.

## Configuring the Precision of Tolerances in Design Tables

In design tables, `tol_precision` is a new keyword for the existing column header `$TOLERANCE@Dimension`.

`Tol_precision` specifies the number of decimal places for the tolerance value. Valid values: integers from 1 through 8 and `NOM`. Using `NOM` makes the value match the dimension precision, and is the same as selecting **Same as nominal** in the PropertyManager. To use the value specified in Document Properties, omit the parameter.

Example of a design table that controls a tolerance, including the precision of the tolerance (highlighted in yellow):

	A	B
1	Design Table for: Part3	
2		\$TOLERANCE@D1@Sketch1
3	small	SYMMETRIC;0.050000; <b>4</b>
4	medium	BILATERAL;0.150000;-0.050000; <b>3</b>
5	large	LIMIT;0.150000;-0.050000; <b>2</b>

# Displaying Scrollbars

You can turn on scrollbars in drawing documents without turning them on in part and assembly documents.

Previously, the system option **Display scrollbars in graphics view** applied to all document types (parts, assemblies, and drawings). In SOLIDWORKS® 2019, that option is replaced by two new options (one for drawings and one for parts and assemblies).

You cannot change these options while any documents are open.

## To display scrollbars in SOLIDWORKS documents:

1. Close all SOLIDWORKS documents.
2. Click **Tools > Options > System Options > Display**.
3. Select or clear these options:
  - **Display scrollbars in graphics view for parts and assemblies**
  - **Display scrollbars in graphics view for drawings**

# Drawing Open Progress Indicator

The Drawing Open Progress indicator provides information on the status of operations while you open a drawing.

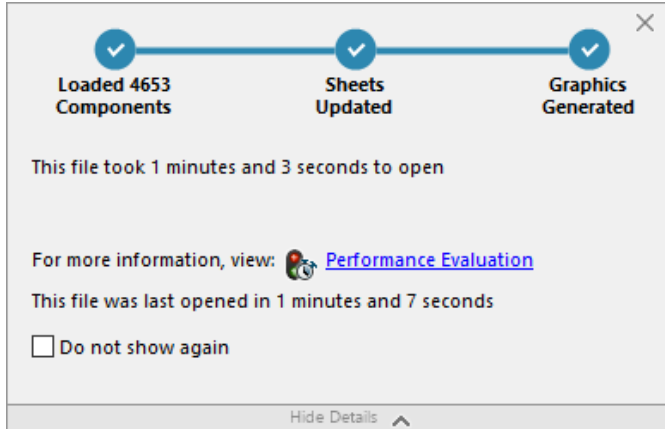

For drawings that take longer than 60 seconds to open, the indicator remains open after the drawing opens.

The indicator provides information on the following operations:

---

### Load Components

Loads the part or the top-level assembly and referenced documents. Shows the number of components opened and the total number of files in the model.

---



<b>Update Drawing</b>	Updates models including mates, assembly features, patterns, and in-context models. If the drawing has multiple sheets, shows the total number of sheets and which sheet is being updated. Click <b>Skip remaining</b> to interrupt loading of sheets after the current sheet.
<b>Update Graphics</b>	Generates graphics.
<b>Elapsed time</b>	Shows the amount of time required to open the drawing.
<b>Previous time to open</b>	Shows the amount of time required to open the drawing the last time the drawing was opened. For assembly drawings, the <b>Previous time to open</b> operation is specific to the assembly mode. This information is saved for Large Assembly mode, Lightweight mode, and Resolved mode.

After opening the drawing, click **Performance Evaluation** in the indicator dialog box to view performance information specific to opening the drawing. To view the performance information at a later time, click **Tools > Evaluate > Performance Evaluation**.

You can suppress the Drawing Open Progress indicator by selecting **Do not show again**. To restore the progress indicator, click **Tools > Options > System Options > Messages/Errors/Warnings**, and select **Drawing Open Progress Indicator**.

## ISO Tolerance-Modifying Symbols

You can add symbols and other text directly to ISO dimensions and their tolerances from the **Tolerance Modifier** section in the Dimensions PropertyManager.

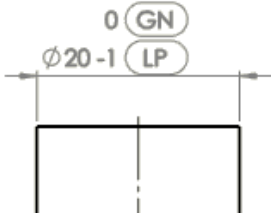
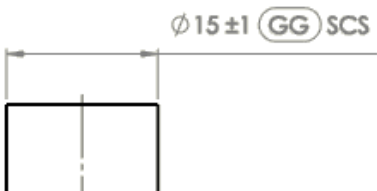
	
Bilateral tolerance with symbols applied to each limit	Symmetric tolerance with symbols applied to the entire dimension

Symbols from the following specifications are available in the Symbol Library, in the new **ISO Tolerancing** category:

ISO 14405-1:2016

ISO 8015

ISO 1101:2017

**To add ISO tolerance-modifying symbols:**

1. In the Dimensions PropertyManager, select **Tolerance Modifier**.







**Tolerance Modifier** is not available if **Tolerance Type** is **None** or **Basic**.

















2. Specify options:



Option	Description
<b>General</b>	Applies symbols and text to the dimension, regardless of tolerance limits.
<b>Specified limits</b>	Applies symbols and text to the upper or lower limit. (Available only when <b>Tolerance Type</b> is <b>Bilateral</b> , <b>Limit</b> , <b>Fit</b> , <b>Fit with tolerance</b> , or <b>Fit (tolerance only)</b> ).

3. Click in the text box and click **More Symbols**  > **More Symbols**.
4. In the Symbol Library dialog box, under **Categories**, select **ISO Tolerancing**.
5. Select one or more symbols.
6. Click **OK**.

Available Symbols

Symbol	Tag	Description
	<ITOL-LP>	Two-point size
	<ITOL-LS>	Spherical size
	<ITOL-GG>	Least-squares
	<ITOL-GX>	Maximum Inscribed
	<ITOL-GN>	Minimum Circumscribed
	<ITOL-GC>	Minimax
	<ITOL-CC>	Circumference Diameter

Symbol	Tag	Description
	<ITOL-CA>	Area Diameter
	<ITOL-CV>	Volume Diameter
	<ITOL-SX>	Maximum Size
	<ITOL-SN>	Minimum Size
	<ITOL-SA>	Average Size
	<ITOL-SM>	Median Size
	<ITOL-SD>	Midrange Size
	<ITOL-SR>	Range of Sizes
	<ITOL-SQ>	Standard Deviation of Sizes
	<ITOL-C>	Minimax Toleranced Feature
	<ITOL-E>	Envelope Requirement
	<ITOL-F>	Free State
	<ITOL-A>	ISO 8015 Rule
	<ITOL-G>	Least Squares Toleranced Feature
	<ITOL-N>	Minimum Circumscribed Tolerance Feature
	<ITOL-T>	Tangent Tolerance Feature

Symbol	Tag	Description
	<ITOL-X>	Maximum Inscribed Tolerance Feature
ACS	<ITOL-ACS>	Any Cross Section
SCS	<ITOL-SCS>	Specified Cross Section
ALS	<ITOL-ALS>	Any Longitudinal Section
CT	<ITOL-CT>	Common Tolerance
UF	<ITOL-UF>	United Feature
	<ITOL-IBETW>	Between

## Performance Improvements - Detailing and Drawings

- Performance when creating, opening, and editing hole tables has improved for large numbers of holes and for the combination of circular and noncircular holes.
- The time it takes to switch from a model to its drawing under the following conditions is improved:
  - Both the model and its drawing are open.
  - You make changes in the model that do not change geometry.
  - The drawing has multiple sheets.
  - **Automatic view update** is selected.

# Removed Section Views

Removed section views show slices of the model at selected locations along a drawing view.

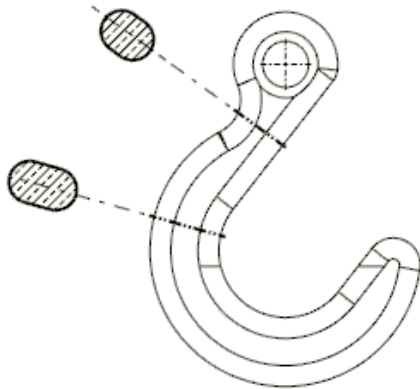

## Creating Removed Section Views

You use the **Removed Section** tool to create views of slices along a drawing view.

**To create a removed section view:**

1. In a drawing, select a view.
2. Click **Removed Section**  (View Layout CommandManager tab or Drawing toolbar).
3. In the PropertyManager, for **Edge** and **Opposed Edge**, select two edges from the same drawing view.

The edges must be opposed or partially opposed geometry between which a solid body can be cut.

4. Select a cutting line placement method:

Option	Description
<b>Automatic</b>	Shows a preview of the cutting line within the area between the opposing model edges. Move the pointer and click to place the cutting line.
<b>Manual</b>	Positions the cutting line between two points that you select on each of the opposing model edges.  Hover near one end of the cutting line and click to place it. Repeat for the other end of the line.

5. Move the pointer and click to place the view.
6. In the PropertyManager, specify other options.

- Click ✓.

# Tables

## Changing Cell Border Thickness ★

In tables, you can change the border thickness of individual cells, selected groups of cells, and entire tables. You can also remove cell borders.

### To change the cell border thickness:

- Select one or more cells.

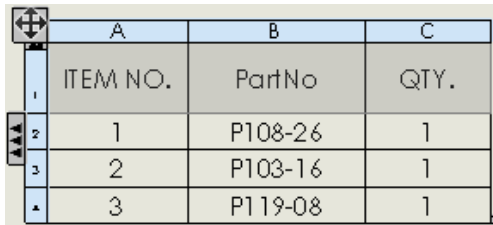

	A	B	C
1	ITEM NO.	PartNo	QTY.
2	1	P108-26	1
3	2	P103-16	1
4	3	P119-08	1

To select cells, you can:

- Click, **Ctrl** + click, or **Shift** + click in cells.
- Click a column letter or a row number.
- Click  to select the entire table.

- On the pop-up toolbar, click **Border Edit** .

The pointer changes to .

- Move the pointer over a border of the selected cells.

The pointer changes to  when it is over a valid border.

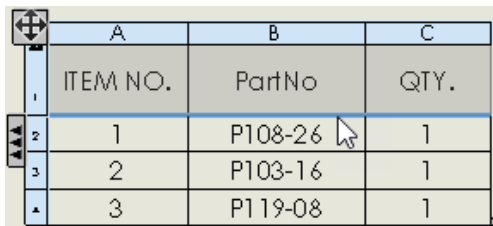

	A	B	C
1	ITEM NO.	PartNo	QTY.
2	1	P108-26	1
3	2	P103-16	1
4	3	P119-08	1

- Click one or more borders of the selected cells and select a new border thickness.

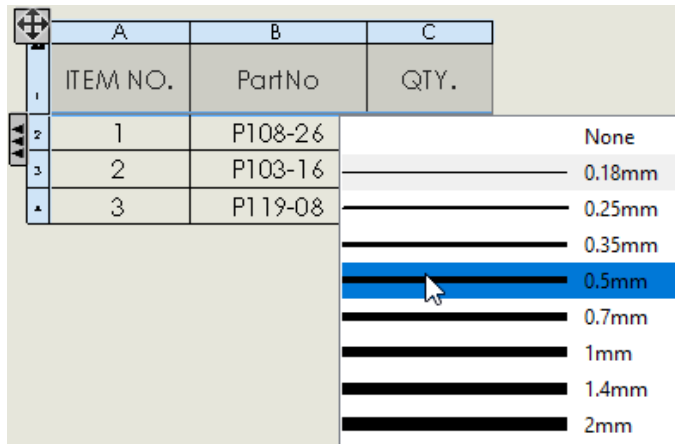

You can:

- Continue clicking and changing other borders of the selected cells.
  - Select **None** to remove the cell border.
- To turn off **Border Edit** , click it on the toolbar or click in a blank region of the graphics area.

ITEM NO.	PartNo	QTY.
1	P108-26	1
2	P103-16	1
3	P119-08	1

- Repeat steps 1 through 4 to change borders on other cells.

ITEM NO.	PartNo	QTY.
1	P108-26	1
2	P103-16	1
3	P119-08	1

## Custom Properties in Lightweight BOMs

When you open a drawing in lightweight mode, notes and tables linked to custom properties show up-to-date values. Previously, the values did not always update if the models changed after the drawing was last saved. To achieve this new behavior, the models must be saved in SOLIDWORKS 2019 or later.

In addition, the precision and units of custom properties in lightweight drawings and assemblies are supported. Tables and notes reflect the Document Properties **Units** settings of the active drawing or assembly without having to resolve the components first. To achieve this new behavior, the models must be created in SOLIDWORKS 2018 or later.

## Customizing Quantity Column Headers in BOMs

In the header of the quantity column in a BOM, you can show or hide custom text and the configuration name independently.

Document properties are provided to define the header independently for each BOM type (**Top-level only**, **Parts only**, and **Indented**).

You can specify the document properties:

- In the document template, before you create the drawing or assembly document
- In the drawing or assembly document, before you create the BOM

### To customize headers of quantity columns:

1. Open a drawing or assembly template or document.
2. Click **Tools > Options > Document Properties**.
3. Under **Drafting Standard**, expand **Tables** and click **Bill of Materials**.
4. For each type of BOM (**Top-level only**, **Parts only**, and **Indented**), specify these properties:

Option	Description
<b>Show custom text in BOM header</b>	Replaces the default text in the header with text that you enter in <b>Custom text</b> . For a blank header, select this option and leave <b>Custom text</b> empty.
<b>Show configuration in BOM header</b>	Adds the configuration name to the header.

5. Click **OK**.

When you create the BOM, the header of the quantity column is defined by the document properties that you specified.

After you create a BOM, you can edit the header of the quantity column:

- Right-click the header and click **Show all configurations** to show or hide the configuration name.
- Double-click the header to edit the default or custom quantity text.

The following document properties are no longer available:

- **Do not add "QTY" next to configuration name**
- **Do not copy QTY column name from template**



## Hole Table Tags - Prefixes, Numbers, and Order

In hole tables, you can create custom tag prefixes, edit tag numbers, and use several methods for defining the tag order.

### Defining Custom Tag Prefixes

You can define multiple custom tag prefixes. In hole tables, you can apply the prefixes to holes you select.

#### To define custom tag prefixes:

- In the Hole Table PropertyManager, under **Tag Type**, select **Manual**, and enter custom tag prefixes.

#### To apply custom tag prefixes:

- In the hole table, right-click a tag cell and click **Assign Tag Prefix**. Then select a tag prefix in the dialog box.

### Editing Tag Numbers in Hole Tables

You can directly edit the tag number for any hole in a hole table.

Double-click in the tag cell in the hole table or double-click the hole label annotation in the drawing view.

### Controlling the Order of Tags in Hole Tables

When you create a new hole table, you can specify the method for defining the order in which the holes are tagged.

Previously, only the **XY** method was available.

In the Hole Table PropertyManager, under **Tag Order**, select a method:

<b>XY</b>	Uses the X-Y coordinates to order the tags closest to the selected datum.
<b>Reduced tool path</b>	Uses the shortest length between all holes of the same size and orders the tags along that path.
<b>Radial</b>	Orders the tags radially for turned or lathe parts.

## Including Thumbnails in BOMs Exported to Microsoft Excel

You can include a thumbnail of each component when you export a table-based BOM to Microsoft® Excel® in the .xls or .xlsx format.

#### To include thumbnails in a BOM:

1. Right-click a BOM and click **Save As**.

2. In the dialog box:
  - a) For **Save as type**, select one of the following:
    - **Excel 2007 (\*.xlsx)**
    - **Excel (\*.xls)**
  - b) Select **Thumbnails**.
  - c) Browse to a folder, enter a file name, and click **Save**.

When you open the file in Excel, thumbnails are included.

	A	B	C	D
1	DOCUMENT PREVIEW	ITEM NO.	PartNo	QTY.
2		1	P108-15	1
3		2	P103-16	1
4		3	P119-08	1
5		4	P107-05	1
6		5	P118-15	1
7		6	P118-09	1

# 12

## eDrawings

---

This chapter includes the following topics:

- **Configurations in SOLIDWORKS Parts**
- **Configurations in SOLIDWORKS Assemblies**
- **eDrawings Performance**
- **eDrawings Professional Features**
- **Perspective Views**
- **Using Ambient Occlusion**
- **Save As Web HTML**
- **Supported File Types in eDrawings**

eDrawings® Professional is available in SOLIDWORKS Professional and SOLIDWORKS Premium.

### Configurations in SOLIDWORKS Parts

You can specify configurations of a SOLIDWORKS part to be available when you open the part in eDrawings®.

In the SOLIDWORKS software, set configurations with **Add Display Data Mark** to view the configurations in eDrawings.

See *SOLIDWORKS Online Help: Opening Part Configurations in Quick View Mode*.

### Configurations in SOLIDWORKS Assemblies

When you open SOLIDWORKS assemblies in eDrawings, you can access all of the assembly configurations that were saved in Large Design Review mode.

### eDrawings Performance

View manipulations and assembly component selections are faster in eDrawings.

To improve performance, click **Tools > Options > General** and select **Graphics boost** and **Fastest speed**.

## eDrawings Professional Features

All eDrawings Professional features from eDrawings 2018 and older are available in the free eDrawings Viewer. This applies to eDrawings for Windows® only (not mobile).

For example, you can measure any file in the eDrawings Viewer, whereas the **Measure** tool used to be available in eDrawings Professional only.

In the SOLIDWORKS software, when you save a file as an eDrawings file, you can still clear the **Okay to measure this eDrawings file** option to prevent measurement of the file in eDrawings. In eDrawings, when you save a file, you can clear **Enable measure**.

All new functionality in eDrawings Professional 2019 and later will be available in eDrawings Professional only.

## Perspective Views

The **Perspective** tool has moved to the **View Settings** tool on the Heads-up View toolbar.



To use perspective views, click **View Settings**  > **Perspective** .

## Using Ambient Occlusion

You can view models with ambient occlusion in eDrawings. Ambient occlusion is a global lighting method that adds realism to models by controlling the attenuation of ambient light due to occluded areas. It also provides clarity between components.

Ambient occlusion can affect performance.

**To use ambient occlusion:**

1. Click **Options**  or **Tools** > **Options**.
2. In the dialog box, on the General tab, under **Performance**, select **Graphics Boost** and **Fastest speed** and click **OK**.
3. Click **View Settings**  > **Ambient Occlusion**  (Heads-up View toolbar) or **View** > **Ambient Occlusion**.

## Save As Web HTML

You can save files as Web HTML files in eDrawings.

Available in eDrawings Professional.

In eDrawings Professional, click **File** > **Save As**. In the dialog box, in **Save as type**, select **eDrawings Web HTML Files (\*.html)**.

# Supported File Types in eDrawings

You can open the following file types in eDrawings.

File Type (Version)	Description
ACIS (Up to 2018.1 (R28))	<ul style="list-style-type: none"> <li>.sat</li> <li>.sab</li> </ul>
AutoCAD® (Up to AutoCAD 2018)	<ul style="list-style-type: none"> <li>.dxf files</li> <li>.dwg files</li> </ul>
Autodesk® Inventor® (Up to 2018)	<ul style="list-style-type: none"> <li>.ipt</li> <li>.iam</li> </ul>
CATIA V5 (Up to V5-6 R2018 (R28))	<ul style="list-style-type: none"> <li>CATPart</li> <li>CATProduct</li> </ul>
CATIA V5 [3DXML] (Up to V5-6 R2018 (R28))	.3DXML
eDrawings (Up to eDrawings 2019)	<ul style="list-style-type: none"> <li>.eprt</li> <li>.easm</li> <li>.edrw</li> </ul>
JT (Up to v10.0)	<p>.jt</p> <p>.JT data format files do not support Product Manufacturing Information (PMI).</p>
Parasolid (Up to v30.1)	<ul style="list-style-type: none"> <li>.x_b</li> <li>.x_t</li> <li>.xmt</li> <li>.xmt_txt</li> </ul>
Solid Edge (V19-20, ST - ST10)	<ul style="list-style-type: none"> <li>.par</li> <li>.psm</li> <li>.asm</li> </ul> <p>Solid Edge files do not support PMI.</p>
SOLIDWORKS (Up to SOLIDWORKS 2019)	<ul style="list-style-type: none"> <li>.sldprt</li> <li>.sldasm</li> <li>.slddrw</li> </ul>

<b>File Type (Version)</b>	<b>Description</b>
Unigraphics-NX (11.0 to 12.0)	.prt

---

# 13

## SOLIDWORKS Electrical

---

This chapter includes the following topics:

- **Black Box Terminals**
- **Cable Cores**
- **Connector Graphical Representation**
- **Conversion to Mixed Scheme Drawing**
- **End Terminations**
- **Input/Output Symbol**
- **Links in Report Drawings**
- **Macro Tool**
- **Option for Dimension Units**
- **Reach a Drawing Dialog Box**
- **Renumber Components Feature**
- **Revisions Management**
- **Saving Symbols as Palettes**
- **Wire Cabling Order Dialog Box**
- **Improved Performance in SOLIDWORKS Electrical 3D**

SOLIDWORKS Electrical is available as a separately purchased product.

# Black Box Terminals

You can represent the black box terminals using a new configuration parameter for specific connection points and attributes.

# Cable Cores

You can switch two cable cores with the **Switch Cable Cores** tool in the shortcut menu of the **Terminal Strip Editor**.

# Connector Graphical Representation

You can use new parameters in the connector configuration files that improve the process of inserting dynamic connectors in schematic drawings.

Use the parameters to:

- Manage a wipeout under the connector
- Add a zig-zag line if the connector representation is incomplete
- Display cross references
- Choose pin sides. Provisions for D-connectors include:
  - **Right**
  - **Left**
  - **Right and left**
  - **Left and right**

# Conversion to Mixed Scheme Drawing

In the Drawing Properties dialog box, you can change the type of drawing from **Schematic** or **Line** diagram to **Mixed Scheme**.

The ability to change the drawing type is only available in the **Admin** mode.

# End Terminations

You can define and manage **End Terminations** at the terminal level of manufacturer components through the Termination Type Manager.

You can use new variables and attributes to display information in reports and schematic drawings about **End Terminations** that are used for components. You can use symbols and manufacturer parts to represent **End Terminations** in schematic drawings. The end wire connected to a component can be different for each type of **End Termination**.



## Input/Output Symbol

From the context menu of the Input/Output List, you can open the drawing that contains the Input/Output symbol.

## Links in Report Drawings

The **Go to** tool automatically generates links to reports in report drawings.

You can also export PDF files with **Go to** links in report components. The links connect to the generated PDF drawings.

## Macro Tool

You can insert a macro as you insert a new symbol, using the **Insert Macro** tool in the **Schematic** and **Line** diagram menus.

## Option for Dimension Units

In the properties of wires, cables, and manufacturer parts, you can choose to display the dimensions in millimeters or inches, using new options in the Project Configuration dialog box.

## Reach a Drawing Dialog Box

In the Search Document dialog box, you can filter searches by **Book**, **Function**, and **Location**.

## Renumber Components Feature

When you renumber components, you can select the type of symbols to use in the project configuration. The symbols determine where the numbering starts.

## Revisions Management

You can manage the revision index through an improved interface that includes ribbon bars and a dialog box that lists the index properties.

## Saving Symbols as Palettes

You can drag symbols from the graphics area to the palette and save them as favorites.

## Wire Cabling Order Dialog Box

You can open the drawing containing the component through the **Go To** tool on the context menu of the component.

## Improved Performance in SOLIDWORKS Electrical 3D

The performance is improved for **Route Cables** and **Route Harness** tools. The

performance is faster when you use the **Route Wires** tool for routing a large number of wires in an assembly.

When you click **Tools > SOLIDWORKS Electrical > Electrical Component Wizard** the Route Library Manager launches quickly and you can define components faster for SOLIDWORKS Electrical 3D.

# 14

## SOLIDWORKS Flow Simulation

---

This chapter includes the following topics:

- **Associated Goals**
- **Customized Visualization Parameters**
- **Edit a Two-resistor from Component Explorer**
- **Flux Measure on Semitransparent Surfaces**
- **Flux Plot**
- **Project Parameters**
- **Surface Parameters in Sections**

SOLIDWORKS Flow Simulation is available as a separately purchased product that can be used with SOLIDWORKS Standard, SOLIDWORKS Professional, and SOLIDWORKS Premium.

### Associated Goals

From the Boundary Condition dialog box, you can select a goal that automatically applies to the boundary condition's reference face or body.

This goal is linked to the boundary condition. Updates to the boundary condition's reference propagate to the associated goal. Removing a boundary condition also removes the goal associated with it.

### Customized Visualization Parameters

You can apply mathematical functions (such as Integral, Min, Max, and Average) and logical expressions (such as IF, More, and Less) to customize visualization parameters.

With customized visualization parameters, you can get more information from the calculated field. For example, you can calculate an area where a required parameter is greater than a specified value.

## Edit a Two-resistor from Component Explorer

You can edit a Two-resistor directly from the Component Explorer table.

## Flux Measure on Semitransparent Surfaces

You can measure incoming radiant flux on surfaces of semitransparent bodies.

## Flux Plot

You can display how much heat transfers from one component to another (by conduction) with a Flux plot.

You can also visualize the heat that flows out of the fluid through convection or radiation. You can group components so that the calculated heat is the total heat flowing in and out of all components. The Pie chart plot for incoming and outgoing heat helps to visualize the balance of heat.

## Project Parameters

A project parameter is a user-defined constant or variable that you can use to define boundary conditions throughout the project.

Use project parameters in dependencies and as custom visualization parameters. You can edit the project parameters in a parametric study.

## Surface Parameters in Sections

You can calculate surface parameters in a section plane.

If a section plane divides a model into several closed contours, you can calculate parameters separately for each contour. This eliminates the need to create a dummy body to measure a fluid's integral parameters (for example, calculate the mass flow rate through a pipe's arm).

# 15

## Import/Export

---

This chapter includes the following topics:

- [Exporting to the PLY File Format](#)
- [Exporting Using Extended Reality](#)

### Exporting to the PLY File Format

You can export SOLIDWORKS part and assembly files to the Polygon® file format (.ply). You can also include the color of the model.

### Exporting Using Extended Reality

The Extended Reality Exporter exports content that powers rich AR, VR, and web experiences.

You can export SOLIDWORKS CAD files to .glb or .glTF file formats. The files contain information such as geometry, appearances, textures, animations, motion studies, configurations, display states, exploded views, lights, and metadata.

You can:

- Import these files into platforms such as Unity or Unreal to create experiences.
- Drag .glb files into Microsoft® Office 365® products like PowerPoint to have interactive 3D model viewing experiences.
- Contact an approved technology provider to create a custom AR, VR, or web experience that suits your needs. For more information or to learn about approved providers, see the [SOLIDWORKS Corporate Blog](#).

Only Approved Provider Viewers support the advanced capabilities of the XR Exported file. These capabilities include Animations, Motion Studies, Exploded views, Display States, Configurations, Decals, and Metadata.

The Extended Reality Exporter:

- Improves collaborative internal and external design reviews.
- Sells designs more effectively with immersive experiences.
- Trains your staff about how to immersively assemble and interact with your products. For example, you can create an Augmented Reality training walkthrough to teach

mechanics how to service an MRI machine when a part breaks, all from the original SOLIDWORKS CAD file.

**To export to the glTF file format:**

1. With a file open, click **File > Save As**.
2. In the Save As dialog box, select **Extended Reality (\*.GLTF)** or **Extended Reality (\*.GLB)**.
3. Select **Options** and specify the settings for exporting Extended Reality files:

<b>Output</b>	<b>Create document sub-directory</b>	Creates a subdirectory that contains the exported material. The subdirectory name is the same as the document name.
<b>Scene</b>	<b>Export Views</b> <b>Export Cameras</b> <b>Export Lights</b>	Exports SOLIDWORKS views. Exports SOLIDWORKS cameras. Exports lights to a Khronos Light Extension (.KHR_Light) file.
<b>Geometry</b>	<b>Collapse Bodies</b> <b>Split meshes at 64k vertices</b>  <b>Auto resolve lightweight geometry</b>	Collapses bodies into a single entity. Splits geometries into chunks that have a maximum of 64k vertices. The chunks are exported as glTF primitive blocks and are seen as an individual geometric object.  Automatically resolves lightweight geometries.
<b>Animations</b>	<b>Export Animations</b>  <b>Export Exploded Views</b>	Exports timeline animations as glTF keyframe sequences.  Exports exploded views animation as glTF keyframe sequences.

4. Click **OK**.

# 16

## SOLIDWORKS 3D Interconnect

---



This chapter includes the following topics:

- **Exporting to the Revit Family Format**
- **Reading Tessellation Data from Foreign CAD Files**

### Exporting to the Revit Family Format

SOLIDWORKS 3D Interconnect can export files to the Revit® family (.rfa) format. The .rfa files contain the custom properties and 3D tessellation of the exported file.

**To export to the Revit family format:**

1. With a model open, click **Tools** > **Export To AEC** .
2. In the PropertyManager, set the options for type and orientation, and click .
3. Specify the export details and click .  
A preview of the model appears.
4. In the **Save Model as** list, select **Revit Family (\*.rfa)**.
5. Select **Export Custom Properties** to export the custom properties of the model.  
You can export SOLIDWORKS custom and configuration-specific properties of the active configuration in the Revit family file.
6. Click **Export**, type a file name and click **Save**.

The software exports the 3D Interconnect file. The PropertyManager closes.

### Reading Tessellation Data from Foreign CAD Files

SOLIDWORKS 3D Interconnect reads tessellated data from third-party CAD files.

The **As Graphical Body** option appears in the Open and Insert Component dialog boxes. This option imports files as graphical 3D meshes instead of solid or surface bodies. You can also load BREP data from the imported part and assembly files.



# 17

## SOLIDWORKS Inspection

---

This chapter includes the following topics:

- **SOLIDWORKS Inspection Add-in**
- **SOLIDWORKS Inspection Standalone**

SOLIDWORKS Inspection is available as a separately purchased product that can be used with SOLIDWORKS Standard, SOLIDWORKS Professional, and SOLIDWORKS Premium or as a completely separate application (see *SOLIDWORKS Inspection Standalone*).

### SOLIDWORKS Inspection Add-in

#### Bill of Characteristics

The Bill of Characteristics is reorganized from a tree to a grid. This condenses the view and simplifies grouping, ungrouping, sorting, and ordering. You also have the ability to personalize and change report formatting.

You can select multiple characteristics using keyboard shortcuts (**Ctrl** + click or **Shift** + click) to reorder characteristics.

New columns support the group/ungroup feature. The columns indicate the **ID #** (balloon number) and **Char #** (characteristic number). This is important because a report could have two characteristics (such as 18.1 and 18.2) but only one balloon (18) in the drawing to save space.

With grouping and ungrouping, you can:

- Group similar characteristics.
- Have multiple characteristics share a unique balloon.
- Mark a unique characteristic as "key".

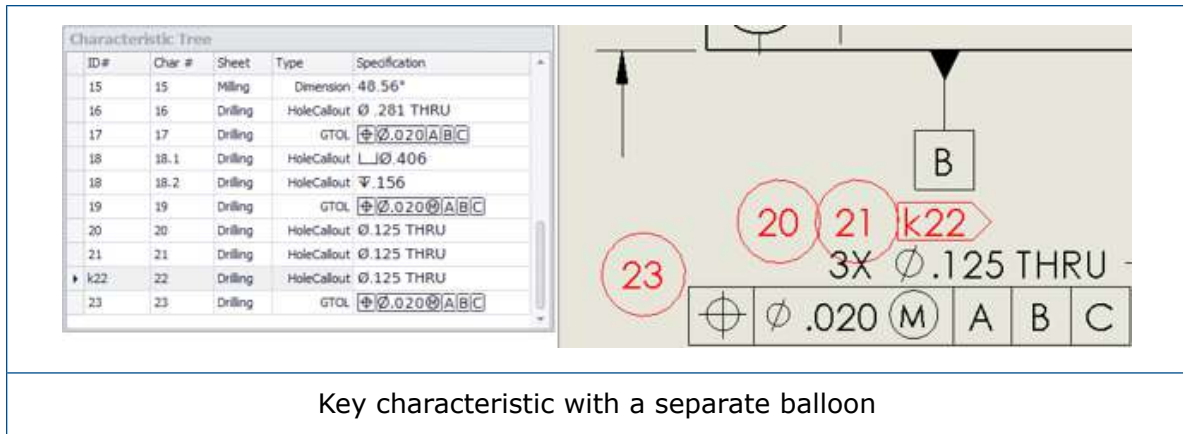

## Custom Properties

You can add an unlimited number of custom properties or choose them from a predefined list (such as **CheckedBy** and **CheckedByDate**).

You often need custom properties to create inspection reports. To save time and standardize processes, define more custom properties at the project level and save them in a template.

You can export the custom properties to a Microsoft® Excel® inspection report or save them in a project template.

## Hole Table Extraction

You can extract all information from hole tables. You can capture all information available in drawings, including complex hole tables.

Balloons appear at the side of hole tables. You can adjust their locations with the options in the **Add/Edit Balloons** menu. You can also hide the balloons.

All information in hole tables is included in the characteristic tree, including the X and Y positions of the holes.

	TAG	X LOC	Y LOC	SIZE
4	A1	13.64	12.91	$\varnothing$ 6.6 THRU ALL $\sqsubset$ $\varnothing$ 14.55 $\nabla$ 4
5	A2	33.50	12.91	
6	B1	58.45	12.06	$\varnothing$ 6.6 THRU ALL $\surd$ $\varnothing$ 12.6 X 90°
7	B2	75.50	12.06	
8	C1	97.21	12.84	$\varnothing$ 6 $\nabla$ 19.05
9	D1	128.10	11.19	$\varnothing$ 14.3 $\nabla$ 18.03 3/8 Rc Tapped Hole

## Zone Support

If you define a zone in a SOLIDWORKS drawing, the balloon zone is automatically calculated for each characteristic. A new field displays the zone in the characteristic's properties.

You can add the zone to a custom Microsoft Excel inspection report using the Template Editor.

Inspection drawings can have hundreds of balloons and it can be difficult to find balloons referenced in the report. Adding the zone to inspection reports helps you find the balloons.

## SOLIDWORKS Inspection Standalone

### SOLIDWORKS PDM Integration

SOLIDWORKS PDM integration is part of SOLIDWORKS Inspection Standalone starting with release 2018 Service Pack 2.0. It helps users include quality management as part of the product development process.

You can access SOLIDWORKS PDM tools such as **Check Out**, **Check In**, **Search**, and **Get Latest Version** using the SOLIDWORKS PDM tab in the CommandManager.

This integration helps quality engineers manage and centralize the storage of inspection projects including the files and reports related to the projects. Version control helps prevent data loss and the **Search** tool reduces the time to search for inspection projects.

# 18

## SOLIDWORKS Manage

---

This chapter includes the following topics:

- **Adding a References Folder Structure**
- **Alternate Options for Mapping Properties**
- **Bill of Materials Performance**
- **BOM Tab Content Indicator**
- **Changing the SOLIDWORKS PDM State Through a Process Output**
- **Configuration File Utility**
- **Copying Custom Values in BOM Items**
- **Document Templates**
- **Duplicate BOM Line Items**
- **Export Template Configuration**
- **Field Group Selection**
- **Full Web Client**
- **Hours for Working Days in Projects**
- **Importing BOM Data from a Microsoft Excel File**
- **Inactive Configuration Handling in Processes**
- **Item Detail Pane for BOM View**
- **Linked Record Objects**
- **List of Recent Documents**
- **Manual Quantity Synchronization**
- **Object Type Hyperlinks**
- **Performance Improvement in Synchronization**
- **Rich Text in Memo Fields**
- **SOLIDWORKS PDM Records in Where Used Tab**
- **Splitting an Auto Number**
- **Splitting Projects into Stages**
- **Support for Internal Components**
- **Thumbnail Images of SOLIDWORKS PDM Files**
- **Updating SOLIDWORKS PDM Variables**

SOLIDWORKS Manage is an advanced data management system that extends the global file management and application integrations enabled by SOLIDWORKS PDM Professional.

SOLIDWORKS Manage is the key element in providing Distributed Data Management.

## Adding a References Folder Structure

You can add a folder structure to organize references similar to the existing folder structure for related files.

**To add a references folder structure:**

1. In the Administration tool, edit an object, and click the Related Files tab.
2. In the **References** section, click **New Folder**.
3. Enter a name for the new folder.
4. Optional: Define the required access rights.
5. Repeat steps 2 to 4 to add more folders.

You can drag the folders to arrange them.

## Alternate Options for Mapping Properties

SOLIDWORKS Manage lets you provide alternate options to map part numbers and description values from SOLIDWORKS PDM files.

The application uses other mapping options when the initial mapping options are not available.

## Bill of Materials Performance

The administrator can specify the number of BOM levels to load when users click the BOM tab of a record for the first time.

This improves BOM display performance for BOMs with thousands of line items.

## Setting the System Display Levels

**To set the system display levels:**

1. Open the Administration tool and select **Advanced**.
2. In the General tab, set the number of BOM levels to display.



## Changing the Level Preference

**To change the level preference:**

1. In the BOM tab, click **Tools** and select **Number of levels to display**.
2. Select the mode to change.
3. Select the number of levels.

This setting is used for all BOM views for that user. Additional levels are loaded when the user expands the level.

## BOM Tab Content Indicator

The empty BOM variants are displayed as . The BOM variants have any line items are displayed as .

## Configuration Part Number Option

When you create virtual configurations or make the inactive configurations active, the **Use Root Part Number + Configuration Name** option combines the parent record's part number with a user-entered string. This option associates the configuration records with their parent records.

## Changing the SOLIDWORKS PDM State Through a Process Output

You can change the state of a promoted SOLIDWORKS PDM file through a process output.

This gives you control of the SOLIDWORKS PDM files that are attached as affected items to a SOLIDWORKS Manage process. This also initiates SOLIDWORKS PDM file tasks from SOLIDWORKS Manage.

### To change the SOLIDWORKS PDM state through a process output:

1. In the Process Management wizard, navigate to the Properties page.
2. In the diagram area, select a stage, and then an output node.
3. Click **New** and select **Change PDM status** from the list.
4. In the Change State Output dialog box, click , and select **PDM Object, Workflow, From State**, and **Transition** from the lists.
5. Click **Save** and **Close**.
6. Optional: Add any additional state changes as required for this stage output and click **Close** in the Change State Output dialog box.

## Configuration File Utility

You can use `swm.configwizard.exe` to test the license server connection and reset the Admin password for SOLIDWORKS Manage.

## Testing the Connection to the SolidNetWork License Manager

### To test the connection to the SolidNetWork License Manager:

1. In the Configuration File Wizard, click **Open**, and select an `.swmc` format file.

2. In **SWM License Server**, enter the license server name, and click **Test Connection**.  
If the connection is successful, a success message appears. Otherwise, ensure that the license server name and part are correct and the license server is running.

## Resetting the SOLIDWORKS Manage Admin Password

### To reset the SOLIDWORKS Manage Admin password:

1. In the Configuration File Wizard, click **Reset Admin account password**.
2. Enter the old SQL database password.
3. Enter a new password.
4. Click **OK**.

Technical Support can use this feature to troubleshoot customer databases.

## Copying Custom Values in BOM Items

You can use the Copy From dialog box to copy custom field values when you copy BOM items from one BOM variant to another.

If the BOM items already exist, the application copies only the custom field values.

The source and target BOM variants must have the same field names and must have compatible data type.

## Document Templates

When you create a new document record, you can select the source file from a SOLIDWORKS Manage document object or a SOLIDWORKS PDM file.

The administrator can control which users can select an existing file.

## Duplicate BOM Line Items

You can add a duplicate row to a BOM. You can assign alternate values to the custom BOM field properties in the new line.

For example, a CAD BOM requires four generic bolts and two of them must have a different finish. Create a single-line item for a bolt and duplicate it. Use custom BOM fields to add the extra information. Use the **Manual Quantity** column to ensure that the total number remains the same.

## Enabling Duplicate Line Item Functionality

You can enable duplicate line item functionality for each BOM variant.

**To enable the duplicate line item functionality:**

1. Open the Administration tool or right-click an object in the window and click **Tools > Administration**.
2. In the **Bill of Materials** section of the object, select an existing BOM variant or create a new one.
3. In the Other Options tab, select **Allow duplicate part numbers**.
4. Click **Save** and **Close**.

## Adding a Duplicate Line Item

**To add a duplicate line item:**

1. Edit a BOM variant.
2. Right-click the line item and click **Duplicate line**.

## Export Template Configuration

The export template configuration has new options to handle more specialized instances.

- **Fixed length output fields**
- **Name output files based on a numbering scheme**
- **Adding all BOM items to a single file**
- **Line item conditions**
- **Exporting multilevel BOMs into parent child files for each level**
- **Setting the templates to be used from other referenced objects**
- **Latest version or as built BOM option**

## Field Group Selection

You can hide certain field groups when you create a new SOLIDWORKS PDM file from SOLIDWORKS Manage.

You can display additional field groups that were added to a SOLIDWORKS PDM object and hide SOLIDWORKS PDM data cards. This lets you use several field groups for a single data card.



## Full Web Client

SOLIDWORKS Manage has a full web client that has the look and feel of the desktop client.

With the full web client, internal users can create and edit product structures through the Item functionality.

The existing web client, which is more suitable for external users, is still available.

The full web client is available as a separate download and is not included in the SOLIDWORKS Installation Manager.

## Hours for Working Days in Projects

You can set the working hours of each day including Saturdays and Sundays. You can use this in calculating the time required to complete a stage based on the time required from all tasks within it.

For example, if you enter 4 working hours for Saturday and 8 hours for Monday-Friday, then you can complete 44 hours of tasks each week. You can set the working hours at the system level and modify them for each project.

Previously, you could select only the working days and each day was set to 8 hours.

## Setting the Default Working Hours

### To set the default working hours:

1. Open the Administration tool or right-click **Projects** in the main user interface.
2. Click **Tools > Administration**.
3. Click in the **Structures** pane and select **Projects**.
4. In the Working hours page, set the hours.

If you change the system working hours, existing projects are unaffected.

## Changing the Working Hours

### To change the working hours:

1. Open and check out an existing project.
2. Select **Planning** to display a Gantt chart.
3. On the toolbar, click **Options**.
4. Set the hours and click **Save**.

# Importing BOM Data from a Microsoft Excel File

You can import bill of materials (BOM) data from a Microsoft® Excel® file. The file must be based on the template defined for the BOM type.

The application only searches for existing records in the same object. If a record does not exist, then the application adds a text line to the BOM. It does not create a new record. When you edit a BOM, use **Replace** to replace a text line with a record.

The import functionality does not support multilevel BOM import.

## Inactive Configuration Handling in Processes

When you add a parent record to a process, the inactive configurations are automatically hidden.

Previously, all configurations, including the inactive ones, were added to the process.

## Item Detail Pane for BOM View

You can view additional BOM details in the item detail pane in the Property Card.

The pane displays the following information about the selected BOM line item:

- **Properties.** Displays references, thumbnails, record status information, and properties. If you select a reference, the reference properties appear.
- **Preview.** Displays a preview of the selected BOM item or a selected reference document of the selected BOM item.

Preview is not available for record objects.

- **Search.** Enables searching for items that you can add to the BOM while in BOM edit mode.

## Viewing BOM Details in the Item Detail Pane

### To view BOM details in the item detail pane:

1. Open the Property Card of a record that has the BOM tab enabled and has a BOM variant defined.
2. In the Property Card of the record, select **BOM** on the left pane.
3. Click the left-pointing arrow at the upper right of the Property Card window to expand the pane.
4. Select a line item in the BOM variant.

# Linked Record Objects

Linked record objects let you use separate but connected items to represent product structures.

The application saves linked records in a separate record object that has a primary reference link to a document record. Primary references are similar to standard references but can also drive field values, thumbnail images, BOMs, related files, and other references. You can check out and edit linked references without checking out the primary reference.

Linked records allow companies to have file data stored in SOLIDWORKS PDM that is controlled by one group but available to other groups with read-only access. For example, an engineering department controls the file data and a manufacturing department has read-only access to it.

You can create a linked record from a document record or independently before a document record exists or is approved. In the latter, a primary reference would not exist but you can add it later.

## Configuring Linked Records

You can configure the linked record in the document object that has the primary reference.

Rules for configuring linked records:

- You need at least one document object and one record object.
- You can link a document object to only a single record object.
- You can link multiple document objects to a single record object.

For SOLIDWORKS PDM Document objects, you access the configuration through a page in the wizard. For standard document objects, a new tab appears at the end of the existing tabs.

Steps to configure:

1. Select a linked record object.
2. Optional: Define the field mapping.
3. Optional: Define the document record's related files or references to link to the linked record.
4. Optional: Map the BOM variants between the document object and linked record object.
5. Optional: Map the field groups to the linked record object.
6. Specify the numbering scheme.

You can also configure a standard document object.

## Selecting a Linked Record Object

**To select a linked record object:**

1. In the SOLIDWORKS PDM Configuration Wizard, under **Linked Record Object**, click **Configure**.

2. In the Link Record Object wizard, on the Linked Record Object page, under **Linked Record Object**, select an object.
3. Under **Initial Record Status**, select a lifecycle status, which is mandatory for newly created records.

## Defining the Field Mapping

You can use the Fields Mapping page to define the mapping of fields between a document objects and the linked record objects.

### To define the field mapping:

1. In the Fields Mapping page, click the cell in the second column that corresponds to the document object's field in the first column.
2. Click the cell in the third column and select an update method:

Option	Description
<b>Blank</b>	Makes no update.
<b>Default if empty</b>	Uses the default value if the document object field is empty.
<b>Always</b>	Always uses the value from the document object field even if it is empty.

3. Optional: Select other available options, as required:

Option	Description
<b>Auto Map</b>	Searches for identical names in the document and record objects and automatically selects the matching record object field.
<b>Update Always</b>	Sets the update method of all the rows to <b>Always</b> .
<b>Use Default if empty</b>	Sets the update method of all the rows to <b>Use Default if empty</b> .

- The field types of the document object and the record object must be compatible.
- If you change a field value in the document record after you initially create the linked record, the application does not automatically reflect the updates. Do the updates manually.

## Defining Related and Reference File Mapping

In the Related and Reference Files mapping page, you can define the document record's related files or references that you can link to the linked record.

You can define this mapping only once when you create a linked record from the document record. If you make subsequent changes to the **Related Files** or **References**, the document record does not automatically update.

**Do not copy the primary file from the document record. This creates a copy of the file, which is not updated, in the linked record.**

### To define related or reference file mapping:

Under **Related Files** or **Reference Files**, click the cell in the second column that corresponds to the document object's folder in the first column.

## BOM Mapping Options

The BOM Mapping Options page maps the BOM variants between the document object and the linked record object.

You can copy the contents of the primary file's BOM variants to the linked records BOM variants. The field names can be different but the field types must be similar.

## Copying BOM Variants

### To copy BOM variants:

1. Click the cell in the second column next to the document object's BOM variant in the first column.
2. Select the linked record object's BOM variant to receive the data.

## Selecting the Custom BOM Field Name

You can select the custom BOM field name for a linked record object.

### To select the custom BOM field name:

1. On the left side of the page, select the BOM variant.
2. On the right side of the page, click the cell in the second column next to the document object's custom field name.

## Mapping the Field Groups to the Linked Record Object

You can use the Field Group options page to map the Field Groups from the document object to the linked record object.

### To map the field groups to the linked record object:

Click the cell in the second column that corresponds to the document object's field group in the first column.

## Numbering Scheme Options

Below are options for the part number assigned to a new linked object record created from a document record.

For new records that you create in the linked object without a primary reference, use the numbering scheme defined for that object.

Numbering Scheme Option	Description
<b>Create New Record Number</b>	Uses the numbering scheme defined for the record object and does not use any value from the document object record.
<b>Use Document Number</b>	Uses a part number from the document object record and has secondary options for replacing existing strings with predefined strings.
<b>Combine Numbering Schemes</b>	Combines the part number from the document object record and the numbering scheme from the linked record object. Secondary options specify which number comes first in the value and whether a delimiter between the values is required.

## Creating Linked Records

You can create linked records directly from the document record or create them independently, and link them to a document record.

### Creating Single Linked Records

#### To create single linked records:

1. Click the main grid of a document object that has been configured for linked records.
2. Right-click a record and click **Records > Create Linked Records**.

The application creates a new linked record in the linked record object.

The linked record number appears in the **Linked Records** column. This is an object type field and allows you to double-click the value to access the linked record's property card. When you view the linked record object, the **Primary Reference** column displays the primary reference as an object type field.

### Creating Linked Records from the Wizard

#### To create linked records from the wizard:

1. Click the main grid of a document object that has been configured for linked records.

2. Right-click a record and click **Records > Create Linked Records with Wizard**.

The Create Linked Record wizard appears and provides additional options for creating linked records.

The linked record number appears in the **Linked Records** column. This is an object type field. You can double-click the value to access the linked record's property card. When you view the linked record object, the **Primary Reference** column displays the primary reference as an object type field.

The Create Link Records page displays the selected document object record and any children from the selected BOM variant.

3. Optional: Select a row on the left side of the page to display the field values to use for the linked record on the right side.

If a linked record already exists for a document object, its part number appears in the **Linked Records** column.

4. Make all required selections, and enter the inputs.
5. Click **Create Linked Record(s)**.

The linked records are created. Closing the wizard does not delete the records.

The status of each linked record appears in the **Status** column. For the successfully created records, the status is **Done**. For any failures, the status is **Failed**.

## Creating BOM Structures of Linked Records

The Create BOM structures of Linked Records page lets you create a BOM that consists of the newly created linked records.

### To create BOM structures of linked records:

1. On the left side of the page, select a record.
2. Click **Create BOMs**.
3. Optional: To see the records in the BOM variant on the right side of the page, reselect the record on the left side.
4. Optional: To edit the BOM variants of the linked record, click **Edit**.

The editing tools appear in the context menu.

## Creating Linked Records Through a Process Output

This method creates the linked record for document objects attached to the process and uses the automated creation method. If an attached document record does not have a linked record object configured, no record is created but the process continues.

## Primary References

Using the create record first method, you can create the linked record and attach a primary file as a reference later.

This method lets you build a product structure using a top-down approach and does not require files. Some records may never have a primary reference.

## Adding a Document Record as a Primary Reference

You can add a document record as a primary reference to an existing record using the standard process.

**To add a document record as a primary reference:**

1. Right-click a record and click **Add Reference**.
2. Right-click the reference and click **Set/Remove as Primary Reference** to set or remove a document record as the primary reference.

Primary references appear in bold and the **Primary** column displays **Yes**.

## List of Recent Documents

The My Dashboard and Shortcuts panel on the right window pane list recently accessed documents.

## Manual Quantity Synchronization

The manual quantity column is synchronized with SOLIDWORKS PDM BOM manual edits.

Enhancements include:

- Bidirectional update of manual quantities from SOLIDWORKS PDM computed BOMs
- Additional synchronization abilities for:
  - Single or selected line items
  - Single or selected line items with children
- Improved highlights:
  - Yellow background indicates edits made before saving the BOM
  - Orange background indicates manual edits
  - Bold text indicates that the manual edits match the actual value

## Object Type Hyperlinks

You can select a particular record to view its details from the multiple values in an object type field.

Double-click an object type field with multiple values to display the Linked Records dialog box, and then select the records to open.



# Performance Improvement in Synchronization

Performance is improved when you synchronize SOLIDWORKS PDM objects with a large number of files and folders. The Synchronization details dialog box displays the synchronization steps.

**To open the Synchronization details dialog box:**

1. Edit a SOLIDWORKS PDM object.
2. In the dialog box, navigate to the Connection page.
3. Select **Show synchronization steps**.
4. Click **OK**.

## Rich Text in Memo Fields

The Memo field types are more flexible and can save rich text into a field value. This lets you display content such as images and formatted text.

### Enabling a Memo Field to Save Rich Text

**To enable a memo field to save rich text:**

1. In the Administration tool, edit the field.
2. In the Options tab, select **Use Rich Text Format**.

When you switch from rich text to plain text, the application deletes the images or text formatting.

### Adding Rich Text to an Enabled Memo Field

**To add rich text to an enabled memo field:**

1. Check out and open a file.
2. Copy an image file or rich text from the file system and paste it into the memo field. You can also copy the image from a word-processing program.

Right-click in the memo field to access text formatting tools.

## SOLIDWORKS PDM Records in Where Used Tab

In the Microsoft® Windows® Explorer view of SOLIDWORKS Manage, in the Where Used tab, you can view SOLIDWORKS PDM records that are attached as deliverables to a project.

## Splitting an Auto Number

You can split auto numbers and add a delimiter if required. Splitting changes only what the users see. The number in the system remains unchanged.

### To split an auto number:

1. Open the Administration tool and select **Advanced**.
2. Select **Numbering schemes**.
3. Do one of the following:
  - Create a new numbering scheme and add an auto number.
  - Edit an existing numbering scheme.
4. Edit the auto number.
5. Select **Split AutoNumber**.
6. Click **Configure**.
7. Click  and enter the delimiter in the first column.
8. Enter the position of the split from the left of the auto number.
9. Optional: Add additional splits.

When you change an existing numbering scheme, the change applies to new records only. The existing records remain unchanged.

## Disabling Auto Increment on Copy From

When you create a new record from an existing one using the **Copy From** option, you can disable the **Auto Number** increment when you use another field. This makes the part number unique.

### To disable auto increment on copy from:

1. Open the Administration tool.
2. On the **Structures** pane, select **Documents and Records**.
3. Edit the object.
4. In the **Fields** section of the object, select the **Field Groups**.
5. Edit an existing field group or create a new one.
6. In the Other Options tab, select **Do not increment AutoNumber by default**.
7. Click **Save** and **Close**.



## Splitting Projects into Stages

You can split the stages of a project to add nonworking time. This can provide a better view of the amount of work required to complete a stage, the start date, and the completion date.

For example, a stage requires 40 hours of work to complete and has a two-week gap when work will not be done. You can split the stage into two 20-hour sections with an 80-hour (two-week) split. Without a split, this stage would cover 3 weeks, and would

appear to have a completion percentage of 17% if 20 hours of work was completed. With the split, the completion percentage would be 50%.

**To split projects into stages:**

1. Open and check out a project or create a new project.
2. In the Planning tab, select a stage where you want to insert the split.
3. Do one of the following:
  - Right-click the stage and select **Split Stage**.
  - In the **Move/Indent** section, on the toolbar, select **Split Stage**.
4. In the Split Stage dialog box, click  and enter a value (in hours) in the **Position** column from where the stage begins to split.
5. Enter the duration of the split in the **Length** column.
6. Click **Apply**.
7. Optional: Click  to insert multiple splits or click  to remove the splits.

## Support for Internal Components

SOLIDWORKS Manage recognizes internal components that are saved in SOLIDWORKS assemblies and checked into a SOLIDWORKS PDM object. These components appear in the BOM views.

## Thumbnail Images of SOLIDWORKS PDM Files

Thumbnail images of SOLIDWORKS PDM files are available in SOLIDWORKS Manage, for example, in the main grid and in BOM views. The application creates these images on check-in from SOLIDWORKS.

SOLIDWORKS Manage creates configuration-specific thumbnails for configurations that you activate during the SOLIDWORKS session and are stored as active records.

## Updating SOLIDWORKS PDM Variables

You can update SOLIDWORKS PDM data card variables with field values from SOLIDWORKS Manage. The field types in SOLIDWORKS Manage can drive data into SOLIDWORKS PDM.

**To update SOLIDWORKS PDM variables:**

1. In the SOLIDWORKS Manage Administration tool, navigate to the Fields Page.
2. Select a variable and click **Edit**.
3. In the Field Properties – ‘Description’ dialog box, in the Field Type tab:
  - a) Select **Updates PDM Variable**.
  - b) Select the **Field Type** and define the parameters.  
The SOLIDWORKS Manage field type and SOLIDWORKS PDM variable must be compatible data types.
  - c) Click **Finish**.

# 19

## SOLIDWORKS MBD

---

This chapter includes the following topics:

- **3D PDF Files**
- **CommandManager Tab Renamed**
- **Copying DimXpert Schemes Across Documents**
- **Display of Cosmetic Threads and Weld Beads**
- **Displaying General Tolerances**
- **Support for Sheet Metal in MBD**
- **Text Size in 3D Views**

SOLIDWORKS MBD is available as a separately purchased product that you can use with SOLIDWORKS Standard, SOLIDWORKS Professional, and SOLIDWORKS Premium.

### 3D PDF Files



#### Adding Security for 3D PDF Files

In SOLIDWORKS MBD, when you publish 3D PDF files you can secure your data.

You can:

- Specify a password and a master password.
- Disable printing, editing, and copying.
- Publish only the graphical data.

##### **To specify security options:**

1. Click **Publish to 3D PDF**  (MBD toolbar).
2. Near the top of the PropertyManager, click **Security Settings** .
3. Specify options in the dialog box, and then click **OK**.

#### Option to Edit 3D PDF Templates

You can set an option to edit the templates that you use when you create 3D PDF files for MBD.

To set this option, click **Tools > Options > System Options > MBD** and select **Allow editing of templates for 3D PDF files**.

## CommandManager Tab Renamed

The SOLIDWORKS MBD CommandManager and toolbars in parts and assembly documents are now named MBD. The name of the product is still SOLIDWORKS MBD.

## Copying DimXpert Schemes Across Documents

In SOLIDWORKS MBD, you can copy DimXpert schemes from one document to another.

1. Open the target document and select the configuration to which you want to copy the DimXpert scheme.

The selected configuration must not have an existing DimXpert scheme.

2. Click **Import Scheme**  (MBD Dimension toolbar).
3. In the dialog box, select a similar document and a configuration that contains the DimXpert scheme to copy.
4. Click **Open**.

The DimXpert annotations are copied from the selected document to the open document.

## Display of Cosmetic Threads and Weld Beads

When you publish to 3D PDF files, shaded cosmetic threads and shaded weld beads display correctly.

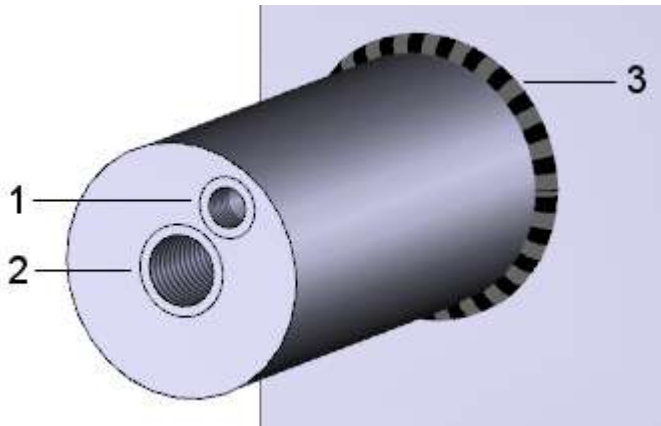

1	Cosmetic thread, partial depth
2	Cosmetic thread, through all
3	Weld bead

## Displaying General Tolerances

When you use a general tolerance, you can display a symmetrical tolerance within the dimension text.

The displayed tolerance is based on the tolerance class specified in parts and assemblies, in **Tools > Options > Document Properties > DimXpert**, under **General tolerance**.

**To display general tolerances:**

1. Click **Location Dimension**  or **Size Dimension**  (MBD Dimension toolbar).
2. In the PropertyManager, under **Tolerance/Precision**, for **Tolerance Type**, select **General with tolerance**.

## Support for Sheet Metal in MBD

SOLIDWORKS MBD supports sheet metal bend notes, bend tables, bend lines, and bounding box lines.

### Bend Notes

You can add and edit bend notes in the flat pattern of a sheet metal part.

In the FeatureManager® design tree, right-click the **Flat-Pattern**  feature and click one of these:

- **Insert bend notes**
- **Reinsert bend notes**

### Bend Tables

You can add bend tables for a flat pattern of a sheet metal part.

Click **Bend Table**  (Table toolbar) or **Insert > Tables > Bend Table**.

The bend table is created and tags are placed on the bend lines of the sheet metal flat pattern to identify their bend specifications.

### Bend and Bounding Box Lines

In the **Sheet Metal MBD** section of the Document Properties dialog box, you can specify the color and line type for various sheet metal items.

Click **Tools > Options > Document Properties > Sheet Metal MBD**.

You can specify the color and line type for:

- Bend lines
- Bounding box lines
- Sheet metal sketch entities

## Text Size in 3D Views

You can control the text size in 3D Views.

In **Tools > Options > Document Properties > Detailing**, these properties are now supported:

---

<b>Always display text at the same size</b>	Displays all annotations and dimensions at the same size, regardless of zoom.
<b>Text scale</b>	Specifies the scale for the default size of annotation text. If you specify <b>Text scale</b> in a 3D View, the text size applies to the 3D View in published 3D PDF files.

---

# 20

## Model Display

---

This chapter includes the following topics:

- **Animation Output File Types**
- **Model Display Performance Improvements**
- **Rendering Performance Improvements**
- **Transforming Textural Appearances with the 3D Texture Tool**

### Animation Output File Types

You can save animation outputs to new file formats.

New Animation Output Formats	Notes
.tiff, .png, or .jpg	For still images, you create in the MotionManager.
<ul style="list-style-type: none"><li>• <b>Microsoft AVI file (*.avi)</b></li><li>• <b>MP4 Video File (*.mp4)</b></li><li>• <b>Flash Video File (*.flv)</b></li><li>• <b>Matroska Video File (*.mkv)</b></li><li>• <b>Series of JPEG (*.jpg)</b></li><li>• <b>Series of Windows Bitmaps (*.bmp)</b></li><li>• <b>Series of Truevision Targas (*.tga)</b></li><li>• <b>Series of Portable Network Graphics (*.png)</b></li><li>• <b>Series of Tagged Image File Format (*.tiff)</b></li><li>• <b>Luxology Scene (*.lxo)</b></li></ul>	For <b>MotionManager Timeline &gt; Save Animation</b> .

You can select **SOLIDWORKS screen** or **PhotoView 360** as the renderer while saving the output file formats.



# Model Display Performance Improvements

## Render Pipeline

SOLIDWORKS 2019 uses a new graphics architecture for parts and assemblies. This architecture provides a more responsive, real-time display especially for large models. It takes advantage of modern OpenGL (4.5) and hardware-accelerated rendering to maintain a high level of detail and frame rate when you pan, zoom, or rotate large models. These performance improvements scale up with the higher-end graphics cards not fully supported in previous versions of SOLIDWORKS. These changes do not apply to drawings.

To turn on the new architecture in SOLIDWORKS 2019, select **Tools > Options > System Options > Performance** and select **Enable graphics performance (Beta feature, requires SOLIDWORKS restart)**.

## Rendering Performance Improvements

Rendering performance is improved because the adaptive sampling value for lower-quality settings (Good, Better, Best) has been modified.

## Transforming Textural Appearances with the 3D Texture Tool

The **3D Texture**  tool transforms textural appearances on parts into geometry. You can use the resulting graphics body for manufacturing, especially 3D printing, or you can manipulate the geometry further by converting it into a mesh BREP body.

Unless a part already has a textural appearance, the process has two steps. First, you map a textural appearance to a model using texture mapping functionality. Second, you use the **3D Texture**  tool to define the geometry for the textural appearance and create the **3D Texture** feature.

In this example, you start with a sample model of a spray gun. You apply a textural appearance to the spray gun's handle, map the textural appearance for fit, then use the **3D Texture**  tool to create and configure grip bumps on the handle. You can then 3D print the model with the bumps.

## Applying a Textural Appearance

A model must have a textural appearance applied to it before you can create **3D Texture** features.

You can use any type of image or mapped textural appearance to create **3D Texture** features. Grayscale heightmap images are preferred. You cannot use decals to create **3D Texture** features.

To apply a textural appearance:

1. Open `system_dir:\Users\Public\Public Documents\SOLIDWORKS\SOLIDWORKS 2019\samples\whatsnew\model display\spray_gun.sldprt`.
2. In the DisplayManager , click **View Appearances** .

3. On the View Appearance tab, drag `grayscale.jpg` from `system_dir:\Users\Public\Public Documents\SOLIDWORKS\SOLIDWORKS 2019\samples\whatsnew\model display` onto the handle's face.
4. Under **Sort order**, right-click `grayscale.jpg` and click **Edit Appearance**.

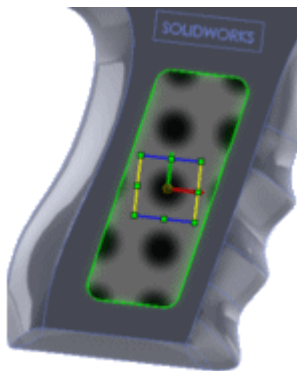



5. In the PropertyManager, click **Advanced**.

- On the Mapping tab, specify the options for **Mapping** and **Size/Orientation** to adjust the fit of the appearance and click ✓.



Try to fit the textural appearance so all the circles are within the handle boundary and do not intersect the surrounding edge. You do this to create a closed, watertight model that you can 3D print.

These are the approximate values to use:

	<b>Mapping type</b>	Projection
→	<b>Horizontal location</b>	0.01640001mm
↑	<b>Vertical location</b>	0.13710199mm
	<b>Fixed aspect ratio</b>	Selected
	<b>Width</b>	10.15549321mm
	<b>Height</b>	10.15549321mm
	<b>Rotation</b>	12.00deg

## Creating 3D Textures

After you add a textural appearance to the model, you use the **3D Texture** tool to transform the textural appearance into grip bumps. You can then manufacture the model and bumps with a 3D printer or other manufacturing methods.

### To create 3D textures:

- Makes sure you opened `system_dir:\Users\Public\Public Documents\SOLIDWORKS\SOLIDWORKS 2019\samples\whatsnew\model display\spray_gun.sldprt` and that you applied the textural appearance.

2. In the FeatureManager® design tree, in the **Solid Bodies** folder, right-click **Imported1** and click **3D Texture**.

In the 3D Texture PropertyManager, under **Body to texturize**, **Imported1** appears. You can apply **3D Texture** features to only one body at a time. The entire body displays as a mesh. The textural appearance mesh displays its initial shape.

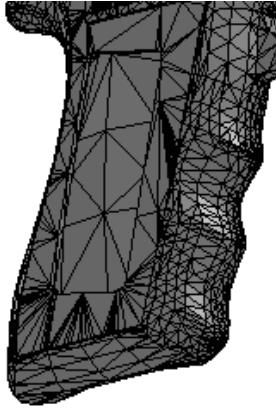

Under **Texture Settings**, note the default values for **Refinement** and **Distance**.

3. Clear **Dynamic Help**, which are expanded tooltips.
4. Under **Texture Settings**, in the table, select `grayscale.jpg` in the first row for **Texture**.

**Convert this texture to 3D** and **White up Black down** are selected.

5. Clear **White up Black down** to use the black colors from the appearance to create the maximum offset distance of the 3D texture feature.

The icon in the table changes to ▼, indicating that black is up. Specify this option based on the grayscale heightmap you use and the displayed results.

6. Move the slider for **Texture Offset Distance** so the **Distance** value in the table is approximately 12mm.

This value controls the maximum offset distance for the 3D texture from the body.

7. Move the slider for **Maximum Element Size** so the value is approximately 6.10mm.

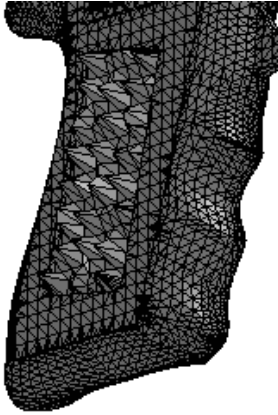

The 3D texture becomes more defined.

This value controls the maximum element size for the entire mesh.

8. Move the slider for **Texture Refinement** so the **Refinement** value is approximately 0.14.

This value controls the local mesh refinement in the area of the 3D texturized feature. Refinement adds facets to better match contours within the grayscale image. When you increase this value, the model display quality increases but the processing time increases too.

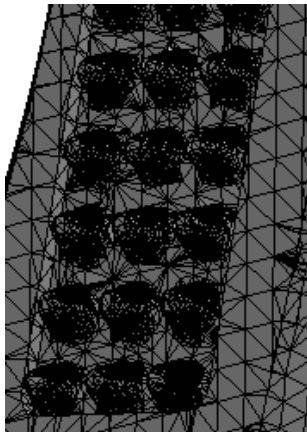

9. The height seems too tall, so move the **Texture Offset Distance** slider to the left to reduce the **Distance** value to 6mm.



The 3D texture mesh becomes smoother.

10. Click ✓.

Recommendation: Because the **3D Texture** feature converts the body to a graphics body, you should add the **3D Texture** feature as the last feature in your part.

The **3D Texture**  feature with a graphics body appears in the FeatureManager design tree. In the **Graphic Bodies**  folder, **Graphic (Closed)**  indicates that the generated model is watertight and that you can 3D print it.

You can then convert the graphics body into a mesh BREP body to use for manufacturing purposes. Select the graphics body and click **Insert > Features > Convert to Mesh Body** .

# 21

## Parts and Features

---

This chapter includes the following topics:

- **Bounding Boxes**
- **Cosmetic Threads Improvements**
- **Creating Partial Chamfers and Fillets**
- **Deleting Holes from Surfaces**
- **FeatureWorks Maintains References in Drawing Views**
- **Inserting a Part with a Specific Configuration**
- **Mesh BREP Bodies**
- **Specifying Tolerances for Hole Wizard Holes**
- **Thumbnail Preview for Blocks in Design Library**
- **Using Interference Detection for Multibody Parts**

### Bounding Boxes

Performance is improved when you use bounding boxes. When you suppress or hide the **Bounding Box** feature, it does not rebuild.

### Cosmetic Threads Improvements

Many issues have been resolved related to how cosmetic threads are created, updated, and displayed when there are child references in downstream features.

The cosmetic threads feature has a more robust architecture so that they behave more consistently. The improved behavior provides more stable references for edges and faces, along with correct parameters for assemblies, drawings, and graphics. Improvements include support for tapered threads, mirrored and patterned geometry, better mapping to nonplanar surfaces, and standards for tapered shafts.

For example::

- When you use the **Split Line** tool to split a face where shaded cosmetic threads display, then rebuild the part, the shaded cosmetic threads and diameter are retained at the correct location.
- Cosmetic threads created from instances of pattern and mirror features display correctly when you hide and show model geometry.
- Cosmetic threads in derived and mirrored parts display in the correct position when you create derived parts using the **Mirror Part**, **Insert Part**, **Saved Body**, and **Split Body** tools.

- Cosmetic threads behave as expected when you copy bodies using the **Move Body** and **Copy Body** tools.
- You have more control when you add features such as chamfers on edges and cosmetic threads are selected, and when you use Hole Wizard to create a hole with cosmetic threads on a reference plane. Also, when you suppress a hole with Hole Wizard, child cosmetic threads are suppressed.
- When you use a design table to assign different values for thread length to each configuration, cosmetic threads update accordingly.

Enhancements include:

- Standards for tapered shafts and holes are supported in cosmetic threads. Also, thread classes are supported when you create cosmetic threads using **Insert > Annotation > Cosmetic Threads**.
- You can input an equation to configure the major or minor diameter of cosmetic threads directly in the Cosmetic Thread PropertyManager.

## Upgrading Legacy Cosmetic Threads

For a part, assembly or drawing that uses legacy cosmetic threads, you must upgrade the model to use the improved cosmetic threads feature. The upgrade requires you to set a system option first, and then you can enable the upgrade for each model.

You can upgrade all cosmetic threads features that are available in components for the top-level assembly and the subassembly.

If you have many files to upgrade, you can use an API method to convert the files (`IModelDocExtension::UpgradeLegacyCThreads`). For information, see the *SOLIDWORKS API Help*. You can also contact SOLIDWORKS Technical Support.

When you upgrade a legacy part, you may need to adjust the assemblies and drawings where the part is used. For example, drawings might have dangling annotations and dimensions.

### To upgrade legacy cosmetic threads in a part, assembly, or drawing:

1. In **Tools > Options > System Options > General**, select **Allow cosmetic threads for upgrade** and click **OK**.

If you are an administrator, you can use the Settings Administrator Tool to propagate this option among your users.

2. Open the model and right-click the top item in the FeatureManager design tree, and click **Upgrade cosmetic thread features**.

After you upgrade, the command, **Upgrade cosmetic thread features**, is no longer available for that model.

## Creating Partial Chamfers and Fillets

You can create partial chamfers and fillets with specified lengths along model edges.

The **Manual** tab of the Fillet PropertyManager and the Chamfer PropertyManager contains a group box where you can specify **Partial Edge Parameters**. When you select an edge





in **Items To Fillet** or **Items To Chamfer**, expand **Partial Edge Parameters** to define the start and end position of the partial feature.

This enhancement is available only for constant size fillets and offset face chamfers.

**To create partial chamfers:**

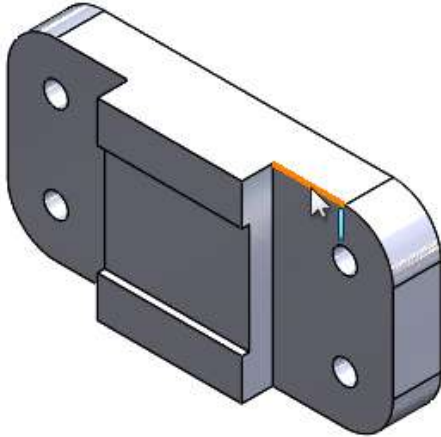
1. Open `system_dir:\Users\Public\Public Documents\SOLIDWORKS\SOLIDWORKS 2019\samples\whatsnew\parts\chamfer.sldprt`.
2. Click **Chamfer**  (Features toolbar) or **Insert > Features > Chamfer**.
3. Right-click the edge shown and click **Select Tangency**.



4. In the PropertyManager:
  - a) Under **Chamfer Type**, click **Offset Face** .
  - b) Select **Full preview**.
  - c) Select **Partial Edge Parameters**.
  - d) In **Start condition**, select **Distance offset**.
  - e) Set **Offset distance from start point** to 20mm.
  - f) In **End condition**, select **Distance offset**.
5. Drag the handles approximately as shown.

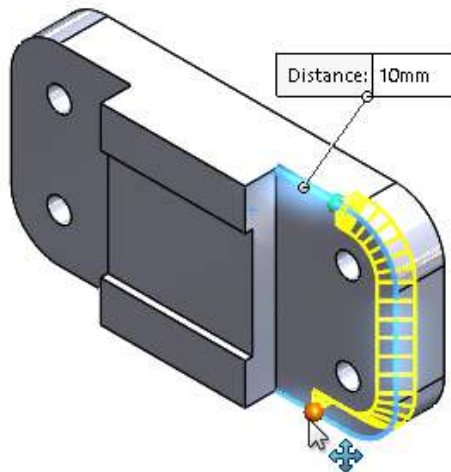

6. Click .

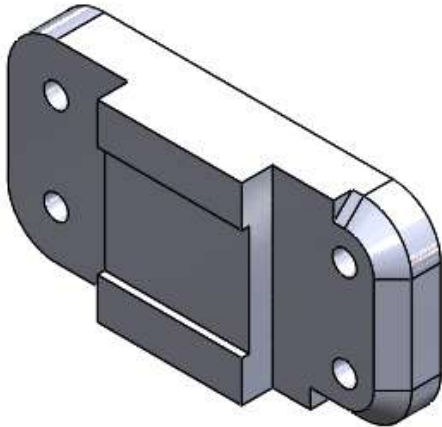

## Deleting Holes from Surfaces

You can delete holes more easily from surface bodies with the **Delete Hole** tool.

To access the tool, do one of the following:

- Click **Insert** > **Surface** > **Delete Hole** .
- In the graphics area, select an edge of a surface hole, right-click, and click **Delete Hole**.

The Delete Hole PropertyManager lists all the edges you select in the **Selections** box.

**Delete Hole** does not support mesh BREP bodies.

Previously, you could only delete a surface hole by pressing **Delete**.

## FeatureWorks Maintains References in Drawing Views

In SOLIDWORKS drawings of imported parts, references are maintained when you change an imported part and FeatureWorks® is enabled.

References are maintained in the following views:

- Model
- Section
- Detail
- Broken-out Section
- Break

# Inserting a Part with a Specific Configuration

The **Insert Part**  tool lets you insert a specific configuration of the part. This workflow is the same as when you insert a component into an assembly.

## To specify a configuration when inserting a part:

1. In any part, click **Insert Part** (Features toolbar) or **Insert > Part** .
2. In the Open dialog box:
  - a) Select the file to insert.
  - b) Select a configuration of the base part.
  - c) Click **Open**.
3. In the Insert Part PropertyManager, under **Part to Insert**, click **Browse** to select another part.

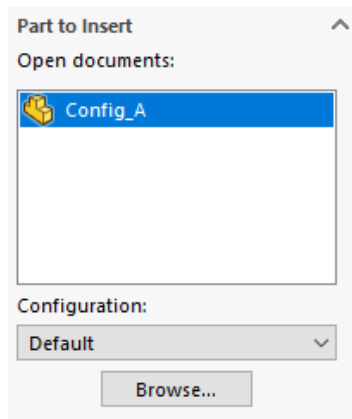

Click  to pin the PropertyManager to insert multiple parts without reopening the PropertyManager.

When you edit a part, the Edit Feature PropertyManager displays the file path and configurations of the part.

## Mesh BREP Bodies

### More Tools for Preparing Meshes

Sometimes mesh files can help you in solid or surface modeling, for example, to create sketches or visual references. There are more tools to help you prepare mesh files for such cases.

Use the **Paint Select** tool to select facets, then to remove them, press **Delete** or use the **Cut with Surface**  tool. The software retessellates the graphics body at the cut boundary.

You can also change the entire size of a graphics body by using the **Scale**  tool.

When you use the **Cut With Surface** or **Scale** tool on a graphics body, the software does not add a feature to the FeatureManager® design tree. This is because these tools modify the original mesh. If you have not saved the graphics body, you can undo the changes but not edit them.

You can access these tools from the **Mesh Modeling** tab in the CommandManager. The **Mesh Modeling** tab contains mesh features and standard features that work with mesh BREP bodies.

## Segment Imported Mesh Body Tool

You can use the **Segment Imported Mesh Body**  tool to group facets of a mesh BREP body into faces bounded by sharp corners, planar faces, and cylindrical faces.

The **Segment Imported Mesh Body**  tool identifies:

- Groups of facets that form planar or cylindrical faces.
- Faces that are separated by a sharp angle or crease angle.
- Planar faces in a mesh BREP body so that you can use them as sketch planes, extrude references, and in other models with planar references.

This tool is most useful for CAD files that you export to mesh and then import into the SOLIDWORKS software and convert to mesh BREP bodies. Although the tool can work with scanned files and bodies with mesh-based sculpting and artistic geometry, these often have very irregular geometry that the software cannot segment.

When you import a mesh file and convert it into a mesh BREP body, each body is represented by a single face. The facets are not grouped or segmented into groups of facets that form faces.

Converting a mesh body to mesh BREP is not like converting standard SOLIDWORKS BREP to mesh BREP, where face definition in the standard SOLIDWORKS BREP is preserved in the mesh BREP.

In the following example, you set system options and import a mesh file. Then you divide the mesh body into crease angle, planar, and cylindrical segments.

## Options for Importing and Viewing Meshes

1. Before you import this mesh file, specify these system options in **Tools > Options > Import:**
  - a) For **File Format**, select **STL/OBJ/OFF/PLY/PLY2** and click **Import as Solid Body**.
  - b) For **Mesh body options**, click **Create mesh bodies bounded by single faces** and for **Unit**, select **Centimeters**.
  - c) Click **OK**.
2. Open `system_dir:\Users\Public\Public Documents\SOLIDWORKS\SOLIDWORKS 2019\samples\whatsnew\parts\segmentmesh.STL`.

3. In the **Heads-Up View** toolbar:

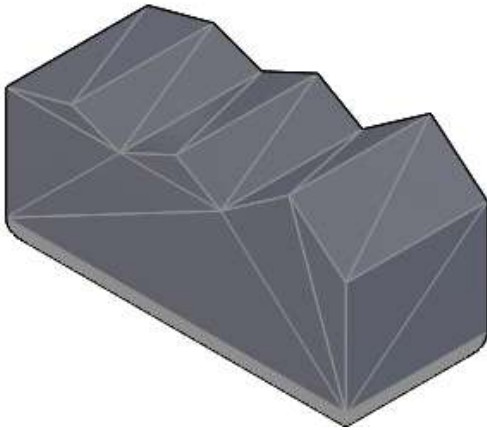

- For **Apply Scene** , click **Plain White**
- For **Display Style** , click **Shaded With Edges** .
- For **View Orientation** , click **Isometric** .

These options help you to better visualize the previews. Now the facet lines in the mesh are visible.



Next, you start segmenting for crease angles.

## Grouping Crease Angle Segments

1. In the FeatureManager tree, right-click **Imported1** and click **Segmented Imported Mesh Body** .
2. Click **Pin**  at the top of the PropertyManager.

**Dynamic Help** displays pop-up tooltips when you move the pointer over controls. Clear it if you do not want to display detailed help.

3. Under **Segmenting**, click **Crease Angle**  and **Select Bodies** . In the graphics area, select the mesh BREP body.
4. Click **Show Preview**.

5. For **Crease Angle Tolerance**, move the slider to 76 degrees. Then lower the tolerance to 30 and even lower to 6 degrees.

As you decrease the tolerance, the preview detects more angular faces on the top of the mesh model. If you decrease the tolerance too far, the software detects the facets on the cylinders, located toward the bottom of the model.

Enter 30 to reset the **Crease Angle Tolerance**.

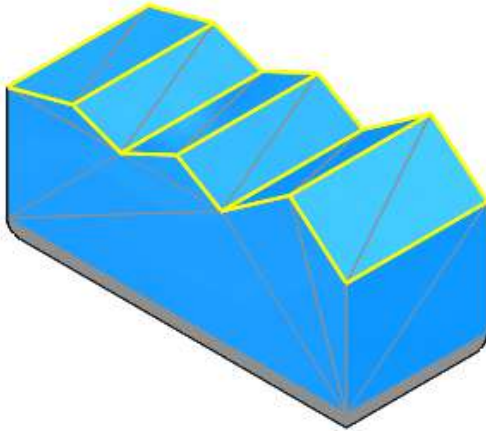

6. Click ✓.

Next, you group planar and cylindrical segments. At that point, the entire mesh BREP body is completely segmented.

Planar faces on the sides and bottom of the mesh BREP body are not detected when you segment crease angles, because the faces are filleted and have no sharp angles.

## Grouping Planar and Cylindrical Segments

1. Under **Segmenting**, click **Planar Segments** and **Select Body** . Then in the graphics area, select the mesh BREP body.
2. Click **Show Preview**.
3. For **Tolerance**, type 6 and click **Recognize Planar Faces**.

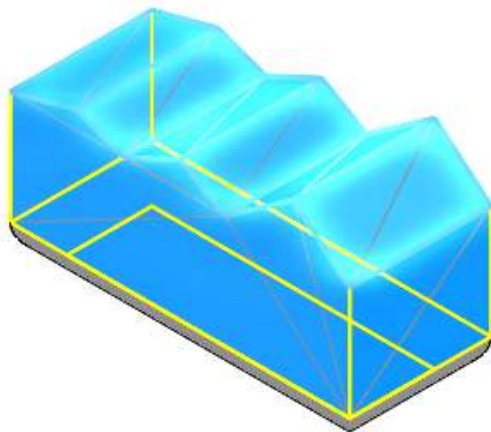

4. Click ✓.
5. Under **Segmenting**, click **Cylindrical Segments** and **Select Body** . Then in the graphics area, click the mesh BREP body.
6. For **Tolerance**, type 20.

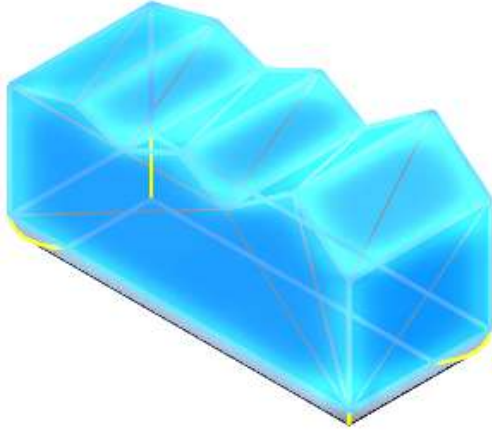

You can rotate the model to view the cylindrical segments more clearly.

7. Click  to unpin the PropertyManager and click ✓.

The FeatureManager design tree lists the angular, planar, and cylindrical segments respectively as **Segment Mesh1**, **Segment Mesh2**, and **Segment Mesh3**. To modify the segments, right-click any of the features and select **Edit Feature** .

## Specifying Tolerances for Hole Wizard Holes

You can set values for tolerance and precision when creating Hole Wizard features.

The **Type** tab in the Hole Wizard PropertyManager includes **Tolerance/Precision**. Depending on the hole type, the PropertyManager displays options for tolerances that apply to the hole specification. This section is also available for Hole Wizard features in assemblies.

Tolerance values automatically propagate to hole callouts in drawings. If you change values in the hole callout, the values update in the part. You can also vary tolerance values for configurations.

Previously, you could only add parameters for tolerance and precision to Hole Wizard holes by manually modifying hole callouts in drawings.

### To specify tolerances for Hole Wizard holes:

1. Open `system_dir:\Users\Public\Public Documents\SOLIDWORKS\SOLIDWORKS 2019\samples\whatsnew\parts\tolerance.sldprt`.
2. In the FeatureManager design tree, right-click **CBORE** and click **Edit Feature**.
3. In the PropertyManager, on the **Type** tab, expand **Tolerance/Precision**.

4. Under **Tolerance/Precision**, in **Callout Value**, select **Thru Hole Diameter**.
  - a) For **Tolerance Type**, select **Bilateral**.
  - b) For **Maximum Variation**, type **0.05mm**.
  - c) For **Minimum Variation**, type **-0.02mm**.
5. Under **Tolerance/Precision**, in **Callout Value**, select **CounterBore**.
  - a) For **Tolerance Type**, select **Symmetric**.
  - b) For **Maximum Variation**, type **0.05mm**.
  - c) For **Unit Precision**, select **.12 (Document)**.
6. Click .

If you make a drawing from the part, the tolerance values display in the hole callout.

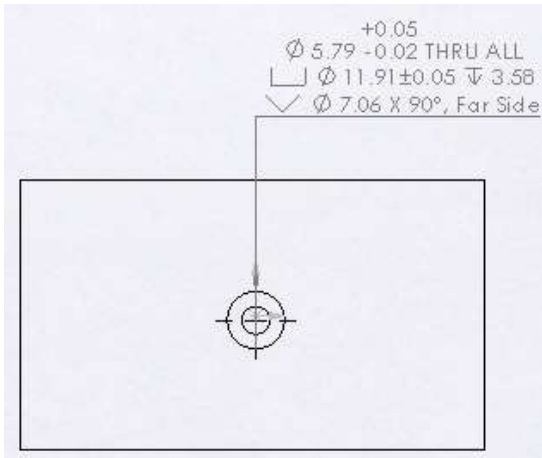

## Thumbnail Preview for Blocks in Design Library

When you open the Design Library, blocks appear as thumbnail images. Previously, all blocks had the same icon. Previews only appeared if you hovered over the icon.

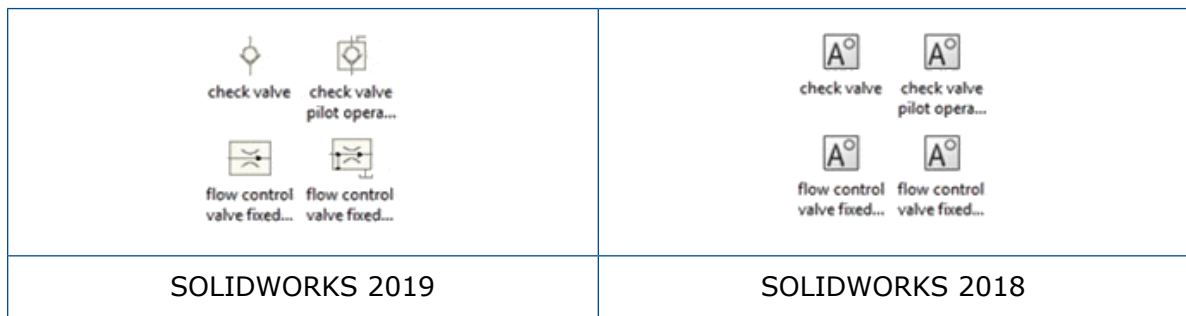

These formats are supported:

- .sldnotestl
- .sldsffvt
- .sldsfstl
- .sldsyt
- .dwg files
- .dxf files
- .sldblk
- .sldnotefvt



- .sldweldfvt
- .sldweldstl
- .sldgtolfvt
- .sldgtolstl

## Using Interference Detection for Multibody Parts





You can use interference detection between bodies in multibody parts. This is helpful when checking that weldments are trimmed properly and before using Simulation tools.

### To use interference detection for multibody parts:

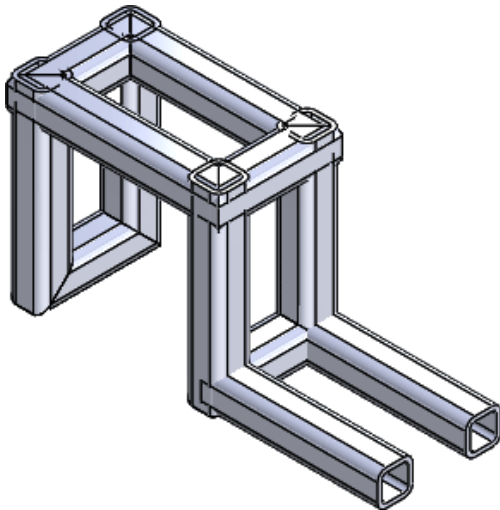
1. Open `system_dir:\Users\Public\Public Documents\SOLIDWORKS\SOLIDWORKS 2019\samples\whatsnew\parts>Main.sldprt`.



2. Click **Interference Detection**  (Tools toolbar) or **Tools > Evaluate > Interference Detection**.  
In the PropertyManager, the `Main.sldprt` is listed under **Selected Bodies**.
3. In the PropertyManager, click in **Excluded Bodies**.

4. In the flyout FeatureManager design tree, select **RH** .

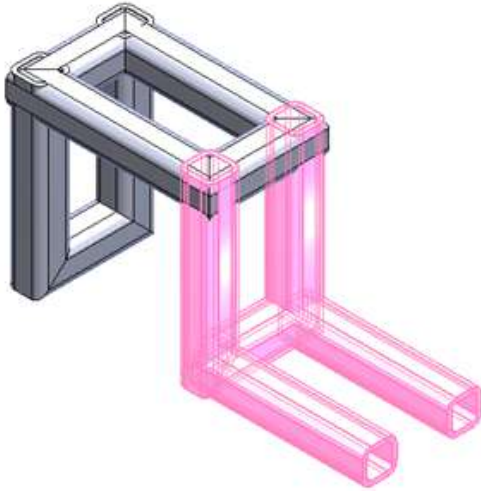

**RH**  was inserted with the **Insert Part** tool. **Interference Detection** can check or ignore parts and bodies that you inserted with the **Insert Part** tool. This saves time if you inserted a part containing several bodies.

In this case, **RH**  will be excluded from the calculation.

5. In the PropertyManager, under **Options**, select:
  - **Treat coincidence as interference.** Includes bodies that share coincident faces as interferences.
  - **Make interfering bodies transparent.** Displays interfering bodies as transparent.
6. Under **Selected Bodies**, click **Calculate**.

Ten interferences are listed under **Results** with the interference value displayed.



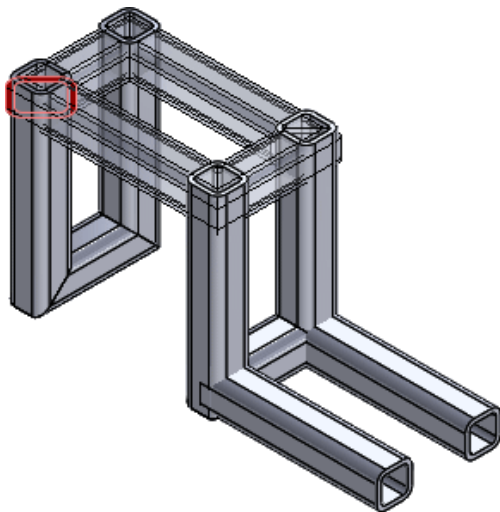

Interfering bodies are transparent, and **Interference1**  is highlighted in the graphics area.

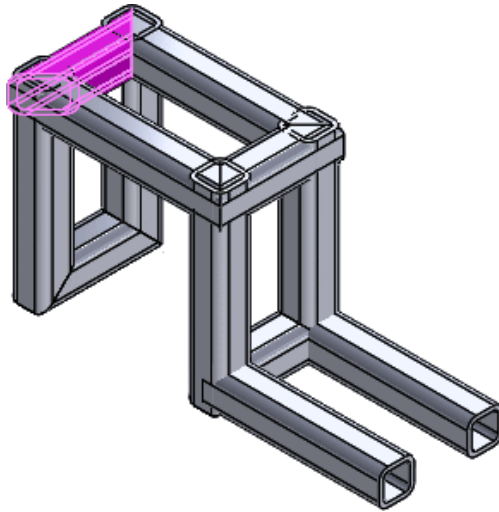

7. Under **Results**:

- a) Expand **Interference1**  and click the first instance of **Square tube** to highlight the interference body in the graphics area.



- b) Double-click **Interference1**  again to clear the **Square tube** selection and collapse **Interference1** .
- c) Press **SHIFT** and click **Interference1**  and **Interference4**  to select all of the interfering sections of bodies.

All of the interfering sections of bodies are highlighted.

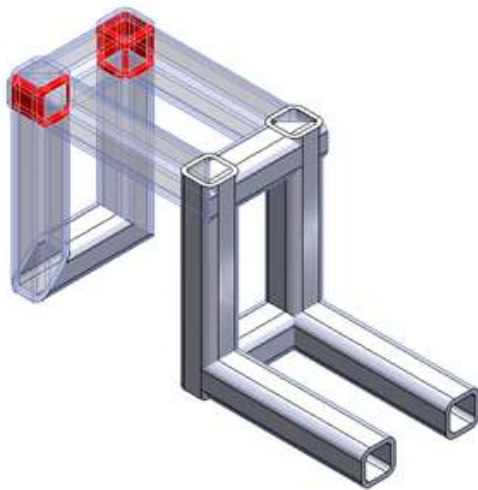

8. Click .

# 22

## SOLIDWORKS PCB

---

This chapter includes the following topics:

- **Mechanical Oriented Workflow**
- **PCB Connector/ECAD-MCAD Collaboration**
- **SOLIDWORKS PCB Miscellaneous Enhancements**

SOLIDWORKS PCB is available as a separately purchased product.

### Mechanical Oriented Workflow

SOLIDWORKS PCB includes enhancements to ECAD-MCAD collaboration that improve mechanical-oriented workflow between mechanical designers and electrical engineers.

Features included in this release are:

- Support of component placement and height barriers from MCAD to ECAD. Mechanical engineers can define and collaborate through PCB Connector any required PCB placement constraints for the surface of the board and the height in the SOLIDWORKS software.



- Support of component locking collaboration between ECAD and MCAD. Mechanical engineers can collaborate through PCB Connector the "fixing" of ECAD components in SOLIDWORKS to protect placement of critical components in the PCB design.



# PCB Connector/ECAD-MCAD Collaboration

ECAD-MCAD collaboration in SOLIDWORKS PCB and SOLIDWORKS PCB Connector includes enhancements that improve mechanical designers' experience with creating and interacting with ECAD data.

## Board Thickness

There is accurate board thickness between ECAD and MCAD.

Board thickness matches the SOLIDWORKS PCB layer stack and a SOLIDWORKS assembly.

## Copper Support

Copper is supported – traces, pads, and polygons – from ECAD to MCAD.

There are two options:

- Decal imagery for reference/visualization.
- Solid modeled copper for all layers.

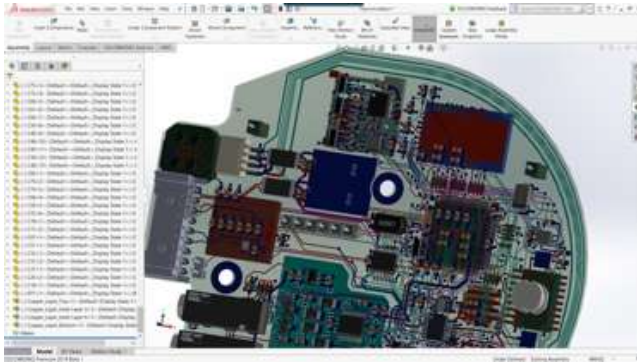

## Flipping Components

You can flip components from MCAD to ECAD.

The SOLIDWORKS software automates the process of reversing an ECAD component on the PCB assembly and changes its location from one surface of the board to the other. Any surface (layer) changes for ECAD components are communicated/collaborated through PCB Connector.

In SOLIDWORKS, right-click a component and click **Flip Component**.

## Multi-contour Hole Sketches

Multi-contour hole sketches are supported between ECAD and MCAD.

SOLIDWORKS ECAD-MCAD collaboration supports any type and method of hole creation for use in PCB design. These methods include patterning, mirroring, Hole Wizard, and so on.

## Silkscreen, Solder Mask, and Solder Paste Support

Silkscreen, solder mask, and solder paste are supported from ECAD to MCAD. These are helpful with decal imagery for reference/visualization.

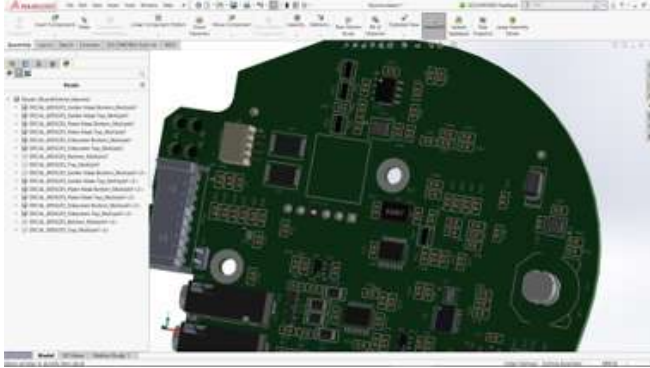

## SOLIDWORKS PCB Miscellaneous Enhancements

Additional enhancements include:

- Redesigned Project Open dialog box in the SOLIDWORKS software features the ability sort and search project lists.
- Added export of DXF/DWG files from SOLIDWORKS PCB layout.
- Documentation workflow capabilities for PCB design using SOLIDWORKS drawings.
- Improved ability to search ECAD parts in the SOLIDWORKS FeatureManager design tree filter.

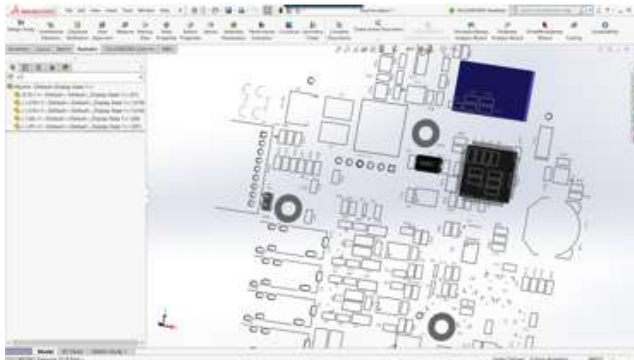

# 23

## SOLIDWORKS PDM

---

This chapter includes the following topics:

- **Conditional Notifications**
- **Default Search Variable in Search Cards**
- **Default Values Generation for New Sheets in Drawings**
- **Editing History Comments**
- **File Shortcut Menu**
- **Integrated Installation of Web API Server**
- **Mixed Authentication Support**
- **Performance Improvements - SOLIDWORKS PDM**
- **Responsive Redesign in Web2**
- **Selection of Referenced Drawing Nodes During Change State**
- **SOLIDWORKS Inspection Integration**
- **Support for Configurations of Weldment Cut Lists**
- **Support for DXF/DWG File Format in Convert Task**
- **Support for eDrawings Functionality**
- **Upload and Check in File Structure and Download with References**
- **User Comments**

SOLIDWORKS® PDM is offered in two versions. SOLIDWORKS PDM Standard is included with SOLIDWORKS Professional and SOLIDWORKS Premium, and is available as a separately purchased license for non-SOLIDWORKS users. It offers standard data management capabilities for a small number of users.

SOLIDWORKS PDM Professional is a full-featured data management solution for a small and large number of users, and is available as a separately purchased product.

## Conditional Notifications

In SOLIDWORKS PDM Professional, you can define conditional notifications for transitions.

With the **Add Conditional Notification** option, you can:

- Add predefined conditions to send transition notifications to users and groups.
- Send notifications dynamically to users based on the value of data card variables.

## Defining Conditional Notifications

### To define conditional notifications:

1. In the Administration tool, click a workflow transition.
2. In the transition's Properties dialog box, in the Notifications tab, click **Add Conditional Notification**.
3. In the Conditional Notification dialog box, in the Recipients tab:
  - a) Click **Add Users/Groups**.
  - b) In the Add Users/Groups dialog box, select the users or groups to receive the notification, and click **OK**.
  - c) Click **Add Variable** to select variables to use their values as notification recipients.
  - d) In the Add Variable dialog box, select the variables, and click **OK**.
4. In the Notification Conditions tab:
  - a) Select **<Click here to add a condition>**.
  - b) In the conditions list, select a variable or a condition.
  - c) Under **Comparison**, expand the list and select a comparison operator.  
The list of operators depends on the selection you made in the previous step.
  - d) Under **Value**, enter the value to compare with the variable value.
 

If you selected **User** or **Group** as **Variable**, select the value from the list.
  - e) If you selected a variable as the condition, specify the data card configuration to search for the variable.  
If you want to search for all configurations, leave **Configuration** blank.
5. Click **OK** twice and save the workflow.

## Conditional Notification Dialog Box

You can use the Conditional Notification dialog box to define conditional notifications for workflow transitions.

### To display the Conditional Notification dialog box:

1. Open the transition's Properties dialog box.
2. In the Notifications tab, click **Add Conditional Notification**.

### Notification Properties Tab

The Notification Properties tab displays the state fields of the transition. These fields are read-only.

<b>Source state</b>	Displays the initial state of the folder.
<b>Destination state</b>	Displays the final state of the folder after transition.
<b>State change</b>	Displays the transition used to trigger the state change.



## Recipients Tab

Use the Recipients tab to define which users and groups receive notification when the condition is met.

---

<b>Add Users/Groups</b>	Opens the Add Users/Groups dialog box. You can select users and groups to receive the notification.
<b>Add Variable</b>	Opens the Add Variable dialog box. You can select variables to use their values as notification recipients. <div data-bbox="609 548 1424 669" style="border: 1px solid gray; padding: 5px; margin: 5px 0;">The value of selected variable is taken from the data card and is compared with the full name, login name, or group name value in the database vault.</div> <div data-bbox="609 688 1424 779" style="border: 1px solid gray; padding: 5px; margin: 5px 0;">You can filter the list to include only variables whose values contain the filter string.</div>
<b>Remove</b>	Removes selected recipients.

---

## Notification Conditions Tab

Use the Notification Conditions tab to create the conditions for users to receive automatic notifications.

The conditional notifications apply on the vault root and all folders by default. To define them for specific file types or file name, you need to define the file path-based conditions.

---

**Variable**

Lists the conditions and variables. You can select a variable or one of the following:

---

**Or**

Creates an OR container. By default, all conditions must be true (AND). Use OR containers to group conditions where only one condition must be true.

---

**Category**

Compares the category of the file with the **Value**.

---

**Filepath**

Compares the file name, extension, or path with the input **Value**. The file path replaces " \*.\* " in the folder path with the input **Value**.

---

**Object type**

Compares the object type (**BOM, File, or Item**) with the **Value**.

---

**Revision**

Compares the revision number of files with the **Value**.

---

**User**

Compares the name of the user who runs the transition with the **Value**.

---

**Group**





Compares the group of the user who runs the transition with the **Value**.

---

**Remove**

Removes the selected condition or variable.

---

<b>Comparison</b>	<p>Lists the comparison operators for each condition.</p> <p>Expand the list to choose a text, numeric, or date comparison operator.</p> <p>For example:</p>
	 <b>Text Does Not Contain</b>  <b>Date Not Equal To</b>
	 <b>Number Less Than</b>  <b>Yes or No Equal To</b>
<div style="border: 1px solid gray; padding: 5px;"> <p>The comparison operators that are available depend on the variable type selected.</p> </div>	
<b>Value</b>	<p>Lets you enter the value to compare with the value of the variable.</p>
<b>Configuration</b>	<p>Specifies the data card Configuration tab to search for the value. This option is available only when the condition is a variable. Leave <b>Configuration</b> blank to search for all configurations.</p>

## Default Search Variable in Search Cards

You can define a logged-in user name as the default value on search cards.

Previously, you had to define the logged-in user name as the default value using a search favorite.

## Configuring the Default Value in Search Card

You can configure the default value in search card to define the default search variable.

### To configure the default value in search card:

1. In the Administration tool, expand **Cards > Search Cards** and double-click a search card.
2. In Card Properties, click **Default Values**.
3. In the dialog box, select a variable and enter a value.

If you select a variable such as **Checked Out by User, Label - by User, Version Created by User, Workflow - Transitions by User, Author**, enter the value as %user%.

- Click **OK** and save the changes to the Card Editor.

In the File Explorer, when you run the Search tool, the logged-in user name appears as the default search value. For example, in step 3, if you select **Checked Out by User**, the logged-in user name appears on the Checked in/out tab in the Search tool.

In the Administration tool, in the Settings - Admin dialog box, if you select **Show full user names** and if the full name is available, it appears in the Search tool.

## Default Values Generation for New Sheets in Drawings

When you add new sheets to a checked-out SOLIDWORKS drawing file, SOLIDWORKS PDM generates default values for the newly added sheets and updates the values in the drawing data card.

Previously, you had to manually update the values of mandatory variables in the drawing data card before check-in.

You must enable the SOLIDWORKS PDM add-in before adding the new sheets.

In the Administration tool, in the SOLIDWORKS Drawing Card, if you select **Updates all configurations**, the variables that use the *\$PRPSHEET* type variable mapping are updated on the tabs for all sheets. Previously, only the values on the as-built (@) configuration tab updated automatically and you had to manually update the active configuration tabs.

## Editing History Comments

You can edit your own history comments only if you have the administrative permission, **Can update history comments**.

Previously, you could edit your own history comments without any permission.

## Set/Delete Labels Permission

The administrative permission, **Can set/delete labels**, is separated into two permissions.

Permission	Description
<b>Can set labels</b>	Lets users add labels.
<b>Can delete labels</b>	Lets users delete any user's labels.

- A user cannot edit other user's labels.
- To make the history read-only for a user, the administrator must clear **Can update history comments** and **Can delete labels**.

## Deleting Labels

You can delete labels with the administrative permission, **Can delete labels**.

### To delete labels:

1. Select the file or folder and click **Display > History** or **History** (Microsoft® Windows® Explorer toolbar).
2. In the dialog box, under **Event**, select labels to delete.
3. Click **Delete Labels**.
4. Click **Yes** to confirm deletion.

## File Shortcut Menu

The file shortcut menu for a user appears in the Where Used, Contains, and Bill of Materials tabs.

You can more easily perform file operations on parent and child references, multiple references, or references that are spread across vaults.

Previously, this menu was only available for Windows Explorer File View. To perform the file operations in these tabs, you had to manually browse or search the files.

The file shortcut menu on the Contains, Where Used, and Bill Of Materials tabs is available in the:

- File Explorer
- Complete Search and Search tool
- SOLIDWORKS PDM File Viewer interface
- Open and Save dialog boxes where access to these tabs exists.

You must have the required permissions to perform the file operations.

The file shortcut menu is:

- Available for computed BOMs, CAD BOMs, and checked-in named BOMs.
- Not available for checked-out named BOMs, weldment BOMs, and cut lists.

## Integrated Installation of Web API Server

EXALEAD® OnePart users can install and configure the Web API server during installation of the SOLIDWORKS PDM Professional server.

Previously, you had to install the Web API server components separately.

EXALEAD OnePart uses Web APIs to access SOLIDWORKS PDM data. With the integrated installation, you can:

- Install the Web API server
- Configure Microsoft Internet Information Services (IIS)
- Add and configure vaults

You can install the Web API server on the same computer with other SOLIDWORKS PDM server components or separately on another computer.

## Mixed Authentication Support

An administrator of a vault can set the option to allow users to log in as Microsoft Windows users and SOLIDWORKS PDM users. Previously, the administrator had to select a single login type for all vault users.

This lets you have a mix of login types per vault. The administrator can have users that are not in the Microsoft Windows domain but need to connect to a vault.

## Authenticating Users with Mixed Logins

**To authenticate users with mixed logins:**

1. Click **Start > All Programs > SOLIDWORKS PDM > Archive Server Configuration**.
2. Click **Default Settings** .
3. Select **Windows login**.
4. Select **Allow SOLIDWORKS PDM login**.
5. Click **Apply** and **OK**.

In the Administration tool, when adding a new user in the Add Users dialog box:

- The new option, **New SOLIDWORKS PDM User**, adds a SOLIDWORKS PDM user.
- The renamed option, **New Windows User**, adds a Microsoft Windows user.
- The renamed option, **List Windows Users**, lists the Microsoft Windows users.

## Performance Improvements - SOLIDWORKS PDM

SOLIDWORKS PDM has improved performance of loads for large assemblies and complex reference structures in the Contains and Where Used tabs.

You can more quickly complete operations such as moving, dragging, browsing, renaming files, and adding a large number of files to a folder that has many files. You can also check in assemblies with virtual components much faster.

Browsing speed has improved while working on integrated search results.

The elimination of unnecessary interface refreshes speeds up your browsing experience, including folders with many locally cached files.

## Responsive Redesign in Web2

The redesign of SOLIDWORKS PDM Web2 makes the website responsive to various device sizes and browser window sizes. The user interface has improved controls plus enhanced support for touch-enabled devices.

Enhancement	Description
Responsive Log In screen	The Log In screen resizes to fit your device and when you resize the browser window.
Responsive and enhanced file list	The file list and file properties also resize with your device. The file list is a continuous scrolling list that lets users browse the vault directory content. Previously, the file list was paginated so users had to navigate through multiple pages.
Navigation bar	The navigation bar lets you: <ul style="list-style-type: none"> <li>• Navigate to different folders in a vault using breadcrumbs.</li> <li>• See the alerts with information on the top bar for file actions such as <b>Change State</b>.</li> </ul>
Action bar	The <b>Check Out, Undo Check Out, Delete, Change State, and Download</b> options are available on the action bar.
Choose column	Select or clear the columns to appear in the file list. When you add a column, its width adjusts automatically.
Resize and sort column	Resize the columns on pages with a column view including the Where Used and Contains tabs.
Upload and Check-In	Drag and drop files to upload and check them in.
Search bar	Designate the search location to <b>Current Folder, Current &amp; Subfolders, or All Folders</b> .
File preview	The file preview resizes to fit your device.

## Selection of Referenced Drawing Nodes During Change State

You can choose to select the referenced drawing nodes associated with a file when changing the file state.

Previously, you could choose to select or clear all referenced files during the change state operation. You could not specify just the referenced drawing nodes.

The new option, **Do not select references that are defined as drawing nodes during change state**, is cleared by default.

To access this option:

1. In the Administration tool, right-click a user or group and click **Settings**.
2. In the left pane of the user's Settings dialog box, click **Reference Dialog**.

When you change the state of the parent file, the software performs as follows:

Option	Description
Selected	Referenced drawing nodes are not selected (the check boxes in the <b>Change State</b> column are not selected) and are excluded from the change state operation.
Cleared (default)	Referenced drawing nodes are selected and included in the change state operation.

If multiple files are selected for the change state operation, the option selects or clears the check boxes for their referenced drawing nodes in the **Change State** column.

## SOLIDWORKS Inspection Integration

SOLIDWORKS Inspection integrates with SOLIDWORKS PDM. The integration covers the SOLIDWORKS Inspection add-in to SOLIDWORKS and the SOLIDWORKS Inspection standalone application.

SOLIDWORKS Inspection standalone supports:

- Variable mapping for inspection project files

SOLIDWORKS PDM lets you map block attributes for the following properties:

- **SWIPrjProperty** defines mapping for Inspection Project Properties.
- **SWICustomProperty** defines mapping for Inspection Custom Properties.

The attribute names available for **SWIPrjProperty** for Project Properties are:

- **Part Name**
- **Part Number**
- **Part Revision**
- **Document Name**
- **Document Number**
- **Document Revision**

- File reference handling

SOLIDWORKS PDM creates references between the inspection project files (.ixprj) and output deliverables (.xlsx, .pdf). In SOLIDWORKS PDM, the Contains tab displays inspection project files as parent files and output deliverables as child references.

In the SOLIDWORKS Inspection add-in, references are created between a drawing file and output deliverables files or between the inspection project file and output files.

- SOLIDWORKS PDM ribbon



SOLIDWORKS Inspection standalone includes the SOLIDWORKS PDM ribbon. You can access SOLIDWORKS PDM features such as Check-Out, Check-In, Search, Get Version, and Get Latest Version using the SOLIDWORKS PDM tab in the CommandManager. This integration helps you manage and centralize the storage of inspection projects plus the files and reports related to them.

## Support for Configurations of Weldment Cut Lists

SOLIDWORKS PDM extracts and displays weldment cut list properties for all configurations. Previously, you could view the cut list properties for the active configuration only.

You can view configurations of weldment cut list properties in:

- Data cards of cut list items
- Weldment BOMs
- Weldment cut lists

This functionality is supported for parts that you create or save in SOLIDWORKS 2019 or later. You must also add **Rebuild on Save Mark** for all configurations.

## Support for DXF/DWG File Format in Convert Task

The Convert task in SOLIDWORKS PDM Professional converts sheet metal flat patterns to the DXF/DWG file format.

SOLIDWORKS 2018 or later supports the conversion.

### Advanced Conversion Options (DWG Format/DXF Format)

You can use the Advanced Conversion Options dialog box to set options when exporting sheet metal patterns to the DXF or the DWG file format.

#### To display the Advanced Conversion Options dialog box:

- When configuring a conversion task, on the Conversions Settings page of the Convert - Properties dialog box, for **Output file format**, select **DWG Format** or **DXF Format** and click **Conversion Options**.
- When initiating a conversion task, in the Convert dialog box, for **Output file format**, select **DWG Format** or **DXF Format** and click **Conversion Options**.

The following options are applied when converting DXF/DWG format files:

<b>Geometry</b>	Exports flat pattern geometry.
<b>Hidden edges</b>	Includes hidden edges (only available if you select <b>Geometry</b> ).
<b>Library features</b>	Exports library features (only available if you select <b>Geometry</b> ).

<b>Forming tools</b>	Includes forming tools.
<b>Bend lines</b>	Exports bend lines.
<b>Sketches</b>	Includes sketches.
<b>Bounding box</b>	Exports bounding boxes.

## Multibody export options

<b>Single file</b>	Converts all flat patterns into a single DXF/DWG format file.
<b>Separate files</b>	Converts each flat pattern into a separate DXF/DWG format file. <div style="border: 1px solid gray; padding: 5px; margin-top: 5px;">The flat pattern name is a suffix on the primary output path.</div>
<b>Enable Map File</b>	Enables the map file and lets you select the location of the map file under <b>Vault Root Folder Path</b> . The file must be accessible on the task host during the task execution.
<b>Reset All</b>	Resets the options to defaults.

## Support for eDrawings Functionality

SOLIDWORKS PDM supports the following eDrawings® functionality:

- Ambient occlusion
- Selection of configuration and sheet

### Ambient Occlusion

SOLIDWORKS PDM supports ambient occlusion for the 3D file formats supported in eDrawings.

To display the eDrawings toolbar on the Preview tab, on the SOLIDWORKS PDM menu bar, click **Display**, and select **Options > Show full UI in SOLIDWORKS preview**. Click  to see ambient occlusion applied to files.

To enable ambient occlusion in files, in eDrawings, click **Tools > Options**, and select **Fastest speed**.

## Selection of Configuration and Sheet

SOLIDWORKS PDM lets you select a configuration and sheet on the Preview tab.

In the Preview tab, on the eDrawings toolbar, you can select:

- Configurations from the **Configurations** list for the .EPRT, .EASM, .SLDPRT, and .SLDASM files.
- Sheets from the list for the .EDRW, .SLDDRW, .DXF, and .DWG files.

## Upload and Check in File Structure and Download with References

The SOLIDWORKS PDM Web2 client provides a faster and easier way to upload and download files and folders with their references.

You can:

- Upload a folder and its contents including files and folders to a specific location.
- Download the files and folders with their references.

Previously, to upload or download a file with its references, you had to perform the operation for each file separately.

The supported browsers for **Check In File Structure** functionality are Google® Chrome, Mozilla® Firefox, and Microsoft® Edge.

## User Comments

SOLIDWORKS PDM lets you control mandatory comments with more granularity during the check-in or change state operations.

With the improved control, the administrator mandates that users add the check-in or state change comments for specific states and transitions in the workflow. These mandatory comments create a reliable document history.

The enhanced permissions are: **Must enter version comments** for each state in workflow and **Must enter state change comments** for each transition.

Scenario	Must enter version comments	Must enter state change comments
Administrative permission is selected and state or transition permission is selected or cleared.	Enter comments during: <ul style="list-style-type: none"> <li>• Initial check-in.</li> <li>• Check in through Copy Tree and Branch operations.</li> <li>• Merge by using the option <b>Merge as new file</b> for at least one file in the reference tree.</li> <li>• Set Revision action when <b>Update Variable</b> is selected.</li> </ul>	Enter comments when you change the state of a file regardless of the transition.
Administrative permission is cleared and state or transition permission is selected.	Enter comments when you check in a file that is in a specific state.	Enter comments when you change the state of a file via a specific transition.

# 24

## SOLIDWORKS Plastics

---

This chapter includes the following topics:

- **Clear Study**
- **Enhanced Cooling Channel Design**
- **Geometry-based Boundary Conditions**
- **Mesh Enhancements**

SOLIDWORKS Plastics Standard, SOLIDWORKS Plastics Professional, and SOLIDWORKS Plastics Premium are available as separately purchased products that can be used with SOLIDWORKS Standard, SOLIDWORKS Professional, and SOLIDWORKS Premium.

### Clear Study

You can use the **Clear Study** feature to reset a SOLIDWORKS Plastics study to its default state.

To delete the features from an active Plastics study, do one of the following:

- Click **CommandManager** > **Clear Study**.
- In the PlasticsManager tree, right-click the top node and click **Clear Study**.

The **Clear Study** feature deletes all boundary conditions, mesh, material, process parameters, and results associated with the active Plastics configuration.

### Enhanced Cooling Channel Design

With the enhanced Cooling Channel creation algorithm, you can build complicated Cooling Channels from the sketch lines with greater precision.

The new algorithm uses the defined Cooling Channel parameters and SOLIDWORKS APIs to build accurate channel geometry. The new algorithm supports the creation of regular cooling channels only. The software applies the algorithm used in 2018 and prior releases for the design of baffles and bubblers.

The advanced settings for solid mesh for the Cooling Channel design generate a hexahedral mesh across the whole cross section. This eliminates any convergence issues encountered in previous releases associated with tetrahedral mesh of the Cooling Channel core. The new meshing algorithm results in a slightly higher number of elements. However, the accuracy of the cooling simulation results is more accurate.

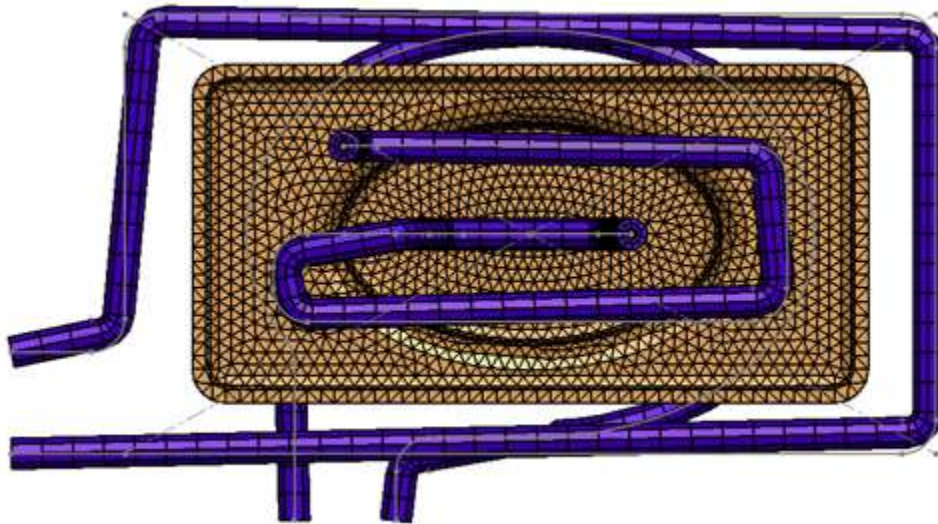

Meshed Cooling Channel (SOLIDWORKS Plastics 2018)

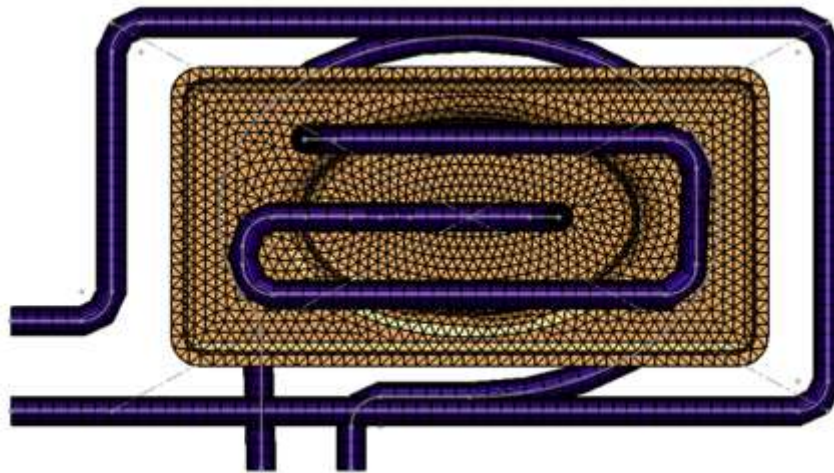

Enhanced mesh for Cooling Channel (SOLIDWORKS Plastics 2019)

## Geometry-based Boundary Conditions ★

You can assign boundary conditions such as Injection Locations, Control Valves, and Mold Wall Temperatures directly on geometry entities.

In the PlasticsManager tree, expand **Boundary Conditions (Geometry Based)**.

In addition to the mesh-based assignment of boundary conditions (applied to elemental nodes or elemental faces), you can assign boundary conditions directly on geometry. This enhancement lets you position Injection Locations or Control Valves more accurately, and

associate the boundary condition assignments directly to geometry when changes to the part geometry occur.

The software saves the boundary conditions you create directly on a part's geometry in the `.sldprt` file. You need to share only the `.sldprt` file so that your team members can view the geometry-based boundary conditions on the model. Configuration-specific study features are also saved.

Geometry-based boundary conditions have limited support for shell meshes.

## Injection Locations on Geometry

You can assign Injection Locations directly to a part's geometry before creating a mesh.

In the PlasticsManager tree, right-click **Boundary Conditions (Geometry Based)**, and click **Injection Location (Geometry Based)**.

Use sketch points or geometry faces that represent the gate cross-section (gate or injection area) to precisely position the Injection Locations.

## Control Valves on Geometry

You can define Control Valve locations using geometry features before meshing.

In the PlasticsManager tree, right-click **Boundary Conditions (Geometry Based)**, and click **Control Valve (Geometry Based)**.

In the Control Valve (Geometry Based) PropertyManager, click one of the two options under **Valve**:

**Manually select the control valve locations** Select the locations to add the Control Valves.

**Automatically find intersecting surfaces** Select to automatically detect all potential Control Valve locations at the intersecting surfaces between cavity and runner bodies.

## Mold Wall Temperature on Geometry

You can assign Mold Wall Temperature boundary condition directly to geometry faces before creating a mesh.

In the PlasticsManager tree, right-click **Boundary Conditions (Geometry Based)** and click **Mold Wall Temperature (Geometry Based)**.

Pin the Mold Wall Temperature PropertyManager to create multiple Mold Wall Temperature definitions on several geometry faces.



# Mesh Enhancements

Several mesh enhancements are implemented in the SOLIDWORKS Plastics 2019 release.

## Create Mesh Before Saving a Part

You can create a mesh before saving a new SOLIDWORKS part file.

The plastics study data are stored in a local temporary folder. When you save the SOLIDWORKS part file, the plastics study features are copied to the folder where the SOLIDWORKS part model is saved.

## Geometry-based Mesh Control

Similar to geometry-based boundary conditions, you can assign local mesh controls over faces, edges, and vertices before the creation of the mesh.

In the PlasticsManager tree, right-click **Mesh** and click **Geometry Based Mesh Control**. Add mesh controls in key areas of interest such as injection locations, gate regions, thickness transition regions, and curved surfaces. You can view/edit the Mesh control definitions under **Mesh**.

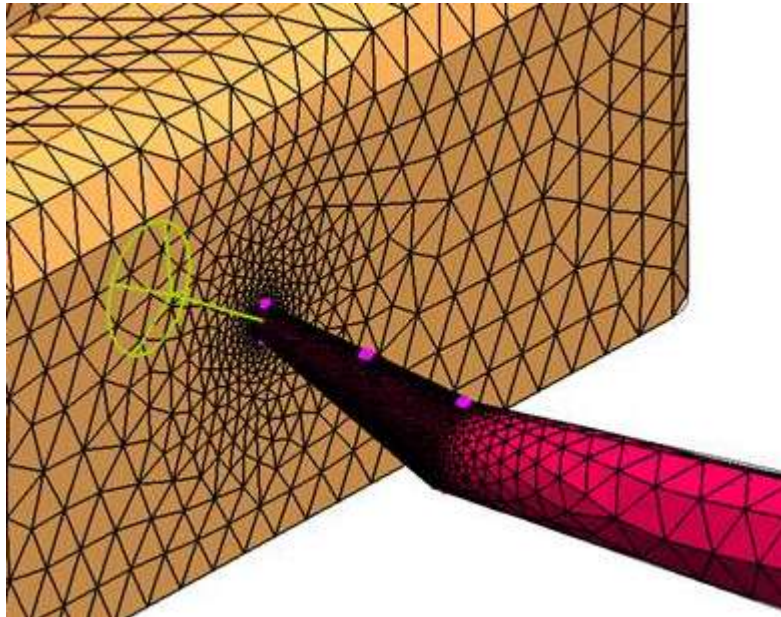

When you have both solid and shell mesh in a study, the inactive mesh node is unavailable. The inactive mesh node is highlighted in gray.



## Mesh Details

After creating a mesh, you can view information about the mesh statistics.

In the plastics tree, right-click **Mesh** and click **Details**. The Mesh Details dialog box displays information about the mesh type, number of shell and solid elements or nodes, and mesh quality data such as maximum aspect ratio and number of bad elements.

## Simplified Mesh Hierarchy

Upon generating the mesh, the selected type of mesh approach appears as a subnode under the Mesh node.

In the PlasticsManager tree, right-click **Mesh** to select the required meshing approach.

## Switching Between Mesh Types

You can detect the active and inactive mesh types under the Mesh node.

When you have both solid and shell mesh in a plastics study, the inactive mesh node is highlighted in gray color. Right-click the inactive mesh node to activate it.

# 25

## Routing

---

This chapter includes the following topics:

- **Configuring Routing Components**
- **Creating Fixed Length Coverings**
- **Fixed Length Covering PropertyManager**
- **Improved Performance with Routing Library Manager**
- **Inline Components**



Routing is available in SOLIDWORKS Premium.

## Configuring Routing Components

You can use the **Configure Component** tool for Routing components with route properties in assemblies when the Routing add-in is enabled.

You must include a component or assembly that has its parameters defined through the Configuration Publisher. For more information, refer to *Configuration Publisher*.

### To configure routing components:

1. Enable the Routing add-in by clicking **Tools** > **Add-Ins** > **Routing** and selecting the option.
2. In an existing assembly, do one of the following:
  - Click **Insert Components**  (Assembly toolbar).
  - Drag a component from the **Design Library**.The Configure Component PropertyManager is displayed.
3. In the Configure Component PropertyManager:
  - a) Specify the parameters.
  - b) Click .
4. In the message box, click **Yes** to save the assembly.
5. In the Route Properties PropertyManager:
  - a) Specify the route properties.
  - b) Click  to complete the configuration.

# Creating Fixed Length Coverings

You can create partial or fixed length coverings for various locations and elements on the route segments.

## To create fixed length coverings:

1. Do one of the following:
  - Click **Fixed Length Covering** (Electrical, Piping, Tubing, and Routing Tools toolbars).
  - Right-click a route segment and click **Fixed Length Covering**.
2. Set the options in the PropertyManager.
3. Click .

## Fixed Length Covering PropertyManager

### Fixed Length Covering

Options	Description
<b>Segments</b>	Lists selected segments in the graphics area.
<b>Covering start point</b>	Lists the covering start point on the route segment.
<b>Offset Distances</b>	Lists the route offset distances between the covering start and endpoints.
<b>Covering distance</b>	Lists the covering length.

### Covering parameters

<b>Use Covering Library</b>	Uses the existing Covering Library.
<b>Create custom covering</b>	Creates a custom covering based on your inputs.
<b>Covering type</b>	Specifies the type.
<b>Covering</b>	Specifies the covering.
<b>Thickness</b>	Sets a value for the covering thickness.
<b>Outer Diameter</b>	Sets a value for the covering outer diameter.
<b>Material appearance</b>	Sets the appearance of the material.

<b>Name</b>	Lists the default name for the material you specified. You can edit the name for the covering instance that you create.
-------------	---

## Covering Layers

Spinner control	Lists the segments and their associated layers. Moves the position of the covering layers inwards or outwards.
-----------------	--

<b>Layer Properties</b>	Lists the properties of the selected covering instance.
-------------------------	---

# Improved Performance with Routing Library Manager

Improved Feature	Description
Routing Component Wizard	<p>When you use the Routing Component Wizard of the Routing Library Manager, the creation of routing library components is more efficient. The wizard displays only the essential tabs that you use to create routing components for different types of routes. The wizard responds faster when you switch tabs.</p> <p>In the <b>Routing Library Manager &gt; Routing Component Wizard &gt; Design Table Check</b> tab, all component-specific column headers are displayed. The design table information is locked. You can edit column headers in the wizard and click <b>Next</b> to apply the changes to the design table.</p> <p>In the <b>Routing Library Manager &gt; Routing Component Wizard &gt; Component Attributes</b> tab, components with multiple configurations load only the active configuration parameters. Other configuration data is loaded only when you select the configuration in the tab, which accelerates the tab's performance.</p>

Improved Feature	Description
Piping and Tubing Database	<p><b>Removing Components</b> To remove components from the database, in <b>Select Components</b>, select <b>Remove Components</b> and click <b>Save</b>.</p> <p><b>Scanning Components</b> To list components not present in the database, in <b>Scan for library components which are not in the database</b>, click <b>Scan</b>. To include scanned components in the database, select <b>Add Components</b> and click <b>Save</b>.</p> <p>The saving and scanning operations are faster. In <b>Routing Library Manager &gt; Piping and Tubing Database &gt; Select Components &gt; Scan for library components which are not in the database</b>, select <b>Scan excluded folders</b>, and click <b>Scan</b> to scan components in the excluded folders. After the scanning process completes, the table displays components that are not in the database. In the table, you can edit and save <b>Type</b> and <b>Sub Type</b> for components.</p> <p>When you click <b>Save</b>, the SOLIDWORKS software opens and saves only selected components with modified <b>Type</b> or <b>Sub Type</b>, and adds them to the database.</p>
Import Data Dialog Box	<p>In the <b>Routing Library Manager &gt; Piping and Tubing Database &gt; Import Data</b>, <b>Start</b> and <b>Synchronize</b> are not available simultaneously, to improve the workflow.</p>
Select Route and Component Type	<p>In the Route Component Wizard, the <b>Select Route Type</b> and <b>Select Component Type</b> tabs are combined to improve access.</p>
Design Table Check	<p>In the Routing Component Wizard, when no Design Library exists for a part, the Design Table Check node is available. A message prompts you to create a new design table.</p> <p>Previously, if no design table existed for a part, the Design Table Check node was unavailable and there was no option to create a new design table.</p>
Images for Connectors in the Routing Library Manager	<p>The Routing Library Manager includes images in <b>Route and Component Types</b>, <b>Routing Geometry</b>, and <b>Routing Functionality Points</b> nodes of the Routing Component Wizard tab.</p> <p>The images help you identify the components.</p>

## Inline Components

Inline components do not require routing specific features. Any components having axes can be added to a route.

Add a route point and axis to a component for adding the component to the junction of a route. The route point associates the components with the junction of the route while the axis aligns the routes.

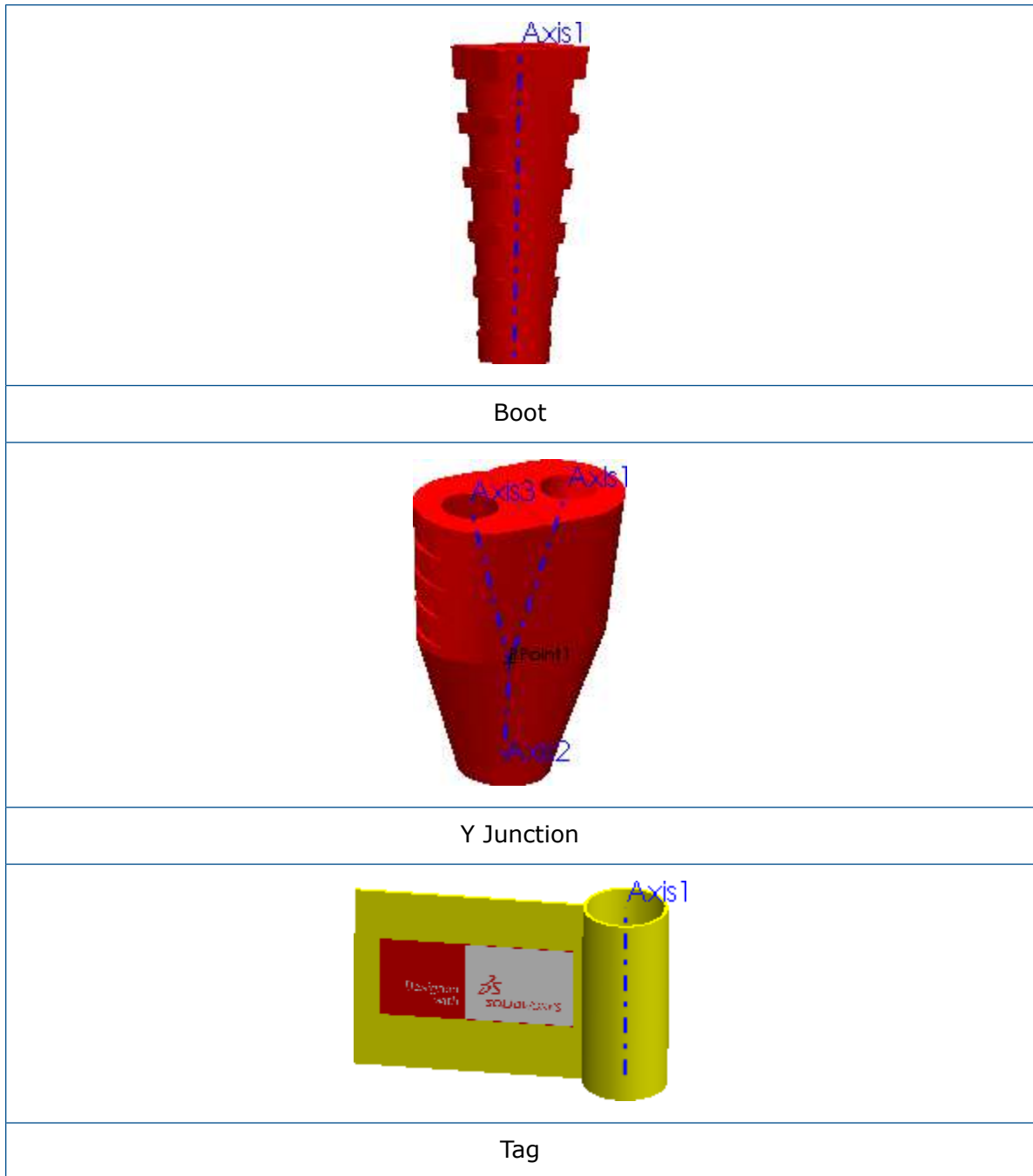

## Adding Inline Components to Routes

You can add inline components, such as shrink wraps and boots, to a route assembly and align them to the route.

**To add inline components to routes:**

1. Drag an inline component from the Routing Design Library.  
The Select a Configuration dialog box or Configure Component PropertyManager appears, depending on the options selected in the Route Properties PropertyManager. The name of the inserted component appears in the **Parts** input box.
2. In the Align Components PropertyManager, click in **Current Selections**.



3. In the graphics area, select:
  - a) A route spline.
  - b) An edge, axis, or point of the component to align.
  - c) Click **Apply**.

The applied selections appear in the **Route Alignments** input box.

You can right-click any input box and click **Delete** or **Remove Selection** to clear the selections.



Assembly without inline components

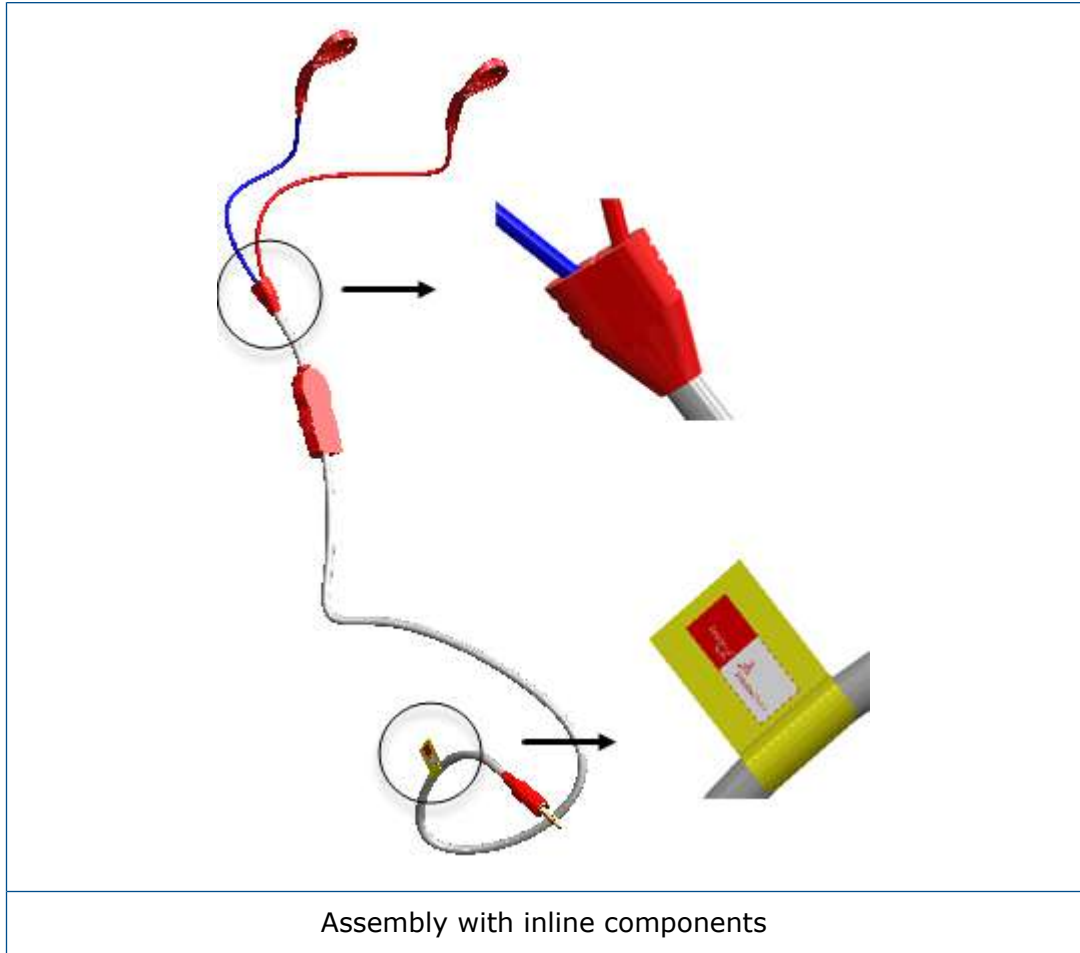

## Align Components PropertyManager

The Align Components PropertyManager aligns components with route segments.

**To open this PropertyManager, do one of the following:**

- Add the component by dragging it to the route segment or the junction point of the route, in the graphics area.
- Right-click the component and click **Align Components**.

Manage the alignment of components to routes.

Options	Description
<b>Parts</b>	Adds a component for alignment.
<b>Current Selections</b>	Adds a route spline and an edge, axis, or point of the component to align.
<b>Apply</b>	Applies the selections made for <b>Parts</b> and <b>Current Selections</b> .

Options	Description
<b>Route Alignments</b>	Displays the alignment routes and the aligned components.

---

## Drawing Options

---

<b>Add component in BOM</b>	Adds components to the bill of materials.
-----------------------------	---

---

# 26

## Sheet Metal



This chapter includes the following topics:

- **Linking Materials and Sheet Metal Parameters**
- **Tab and Slot**

### Linking Materials and Sheet Metal Parameters

When you assign a custom material to a sheet metal part, you can link the sheet metal parameters to the material. If you change the material, the sheet metal parameters also update.

#### To link materials and sheet metal parameters:

1. Open a sheet metal part.
2. In the FeatureManager<sup>®</sup> design tree, right-click **Material**  and click **Edit Material**.
3. In the dialog box:
  - a) Right-click **Custom Materials**  and click **New Category**.
  - b) Right-click **New Category**  and click **New Material**.
  - c) Set the custom material properties on each tab as required.
  - d) Click the Sheet Metal tab.  
Options on this tab are available for custom materials only.
  - e) Select **Thickness Range**.
  - f) Click **Add** twice.
  - g) For each row in the table, set the following:

Row	From	<	<=	To	Unit	Bend Allowance	Value
1	0	<	<=	3	millimeters	K-Factor	0.375
2	3	<	<=	6	millimeters	K-Factor	0.4

Thickness ranges must be continuous; there cannot be a gap in the range. For example, you cannot define a range from 0 to 3 and define the next range from 4 to 6 because the range between 3 and 4 is not covered.

- h) Click **Apply** and **Close**.

# Tab and Slot

Enhancements to the **Tab and Slot** tool include group linking, the use of nonlinear edges, slot corner shapes, and through all cuts.

## Linking Groups

You can link groups of tab and slot features together so that all parameters apply uniformly to the features. If you edit a parameter for a linked group, all of the tab and slot features in the group update accordingly.

To link groups, in the Tab and Slot PropertyManager, under **Selection**, select entities in **Group List** and select **Link Groups Together**.

## Nonlinear Edges

You can select nonlinear edges when creating a tab and slot feature.

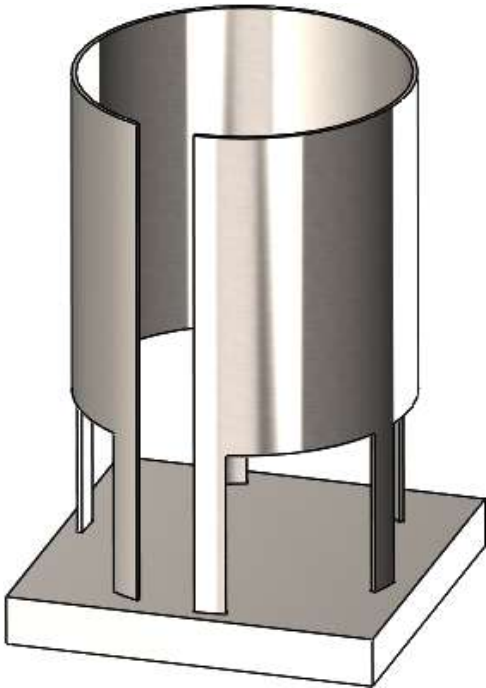

## Slot Corners

You can set the type of corners for slots. In the Tab and Slot PropertyManager, under **Slot**, you can set **Corner Type** to:



**Slot sharp corner**



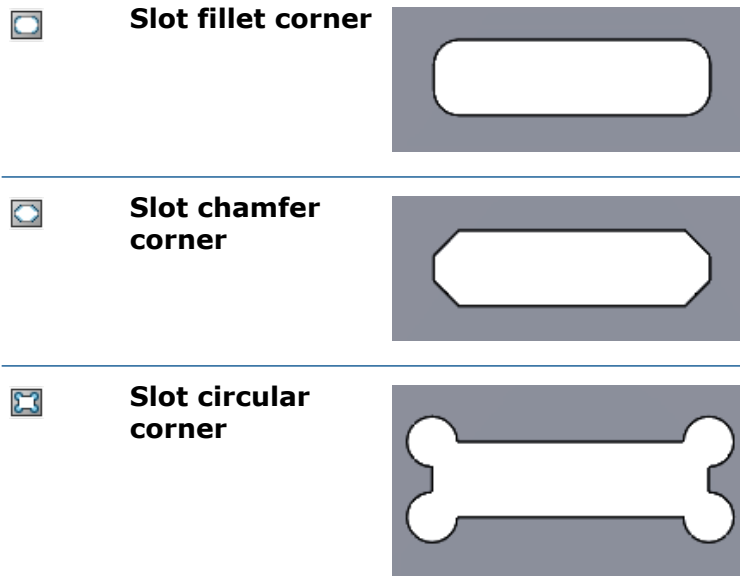

## Slot Length and Width

You can specify the offset values for the length and width of slots. In the Tab and Slot PropertyManager, under **Slot**, you can set:

- **Slot Length Offset** 
- **Slot Width Offset** 
- **Equal offset.** Sets equal values for **Slot Length Offset** and **Slot Width Offset**.

## Through All Cuts

Slots are always created as through all cuts unless the cuts are impractical. If you do not want a through all cut, select **No Through Cut** under **Slot** in the Tab and Slot PropertyManager. If a through cut is impractical for the model (for example, models with a single body), **No Through Cut** is unavailable.

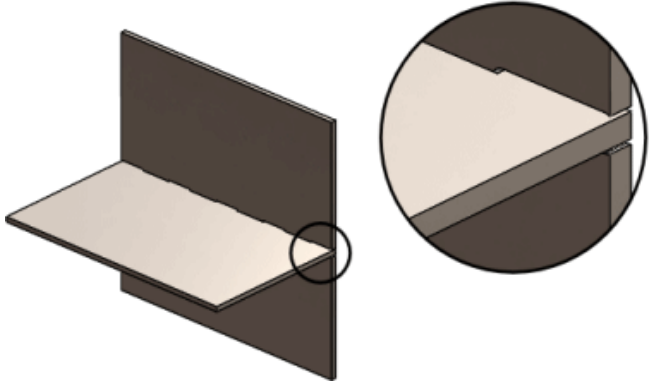
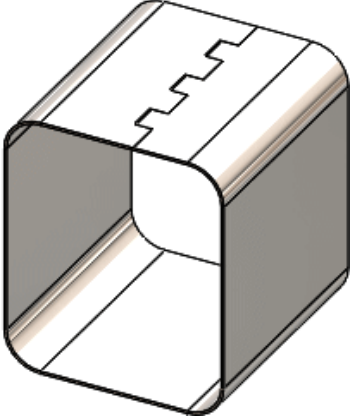
	
<p><b>No Through Cut</b> cleared</p>	<p><b>No Through Cut</b> selected</p>

# 27

## SOLIDWORKS Simulation

---

This chapter includes the following topics:

- **Customized Numerical Format**
- **Enhanced Remote Load/Mass PropertyManager**
- **Distributed Coupling for Remote Load and Mass**
- **Pin Connector**
- **Simulation Performance Improvements**
- **Stress Averaging at Mid-side Nodes**
- **Topology Study**

SOLIDWORKS Simulation Standard, SOLIDWORKS Simulation Professional, and SOLIDWORKS Simulation Premium are available as separately purchased products that can be used with SOLIDWORKS Standard, SOLIDWORKS Professional, and SOLIDWORKS Premium.

### Customized Numerical Format

The Microsoft® Windows® system options you define for formatting numerical values propagate to post processing of simulation results.

You can control the formatting of numerical values (symbols for thousand and decimal separators) when displaying or listing results.

From the Control Panel, select **Region and Language > Formats > Additional settings**. On the **Formats** tab, specify the required symbols for **Decimal symbol** and **Digit grouping symbol** (thousand separator).

These Microsoft Windows system options apply to the numerical format when probing and listing simulation results, and also when displaying callouts in plots (including plots in reports).









# Enhanced Remote Load/Mass PropertyManager





The Remote Load/Mass PropertyManager is redesigned to improve the user experience and enhanced with the introduction of distributed coupling for linear static, nonlinear static, and topology studies.

## To access the Remote Load/Mass PropertyManager:

From a linear static, nonlinear static, or topology simulation study tree, right-click **External Loads**, and click **Remote Load/Mass** .

Legacy Options (Remote Load/Mass)	New Options (Remote Load/Mass)
<p><b>Load (Direct Transfer)</b></p>	<p><b>Connection Type</b> is <b>Distributed</b> with <b>Weighting factor</b> set to <b>Default (constant)</b>.</p> <ul style="list-style-type: none"> <li>Enter force values (X-, Y-, or Z -direction) in <b>Translational Components &gt; Force</b> .</li> <li>Enter moment values (X-, Y-, or Z-direction) in <b>Rotational Components &gt; Moment</b> .</li> <li>Select <b>Mass</b>, to enter the remote mass properties.</li> </ul>
<p><b>Load/Mass (Rigid connection)</b></p>	<p><b>Connection Type</b> is <b>Rigid</b>.</p> <ul style="list-style-type: none"> <li>Enter force values (X-, Y-, or Z -direction) in <b>Translational Components &gt; Force</b> .</li> <li>Enter moment values (X-, Y-, or Z-direction) in <b>Rotational Components &gt; Moment</b> .</li> <li>Select <b>Mass</b>, to enter the remote mass properties.</li> </ul>
<p><b>Displacement (Rigid connection)</b></p>	<p><b>Connection Type</b> is <b>Rigid</b>.</p> <ul style="list-style-type: none"> <li>Enter translation values (X-, Y-, or Z -direction) in <b>Translational Components &gt; Translation</b> .</li> <li>Enter rotation values (X-, Y-, or Z-direction) in <b>Rotational Components &gt; Rotation</b> .</li> </ul>

**Legacy Options (Remote Load/Mass)****Displacement (Direct transfer)****New Options (Remote Load/Mass)****Connection Type** is **Distributed** with **Weighting factor** set to **Default (constant)**.

- Enter translation values (X-, Y-, or Z -direction) in **Translational Components > Translation** .
- Enter rotation values (X-, Y-, or Z-direction) in **Rotational Components > Rotation** .

## Distributed Coupling for Remote Load and Mass



Distributed coupling constrains the motion of the coupling nodes to the translation and rotation of the reference node.

The distributed coupling constraint is enforced in an average sense in a way that enables control of the transmission of loads and displacements through weight factors at the coupling nodes. Distributed coupling allows the coupling nodes of the selected geometry (face or edge) to move relative to each other.

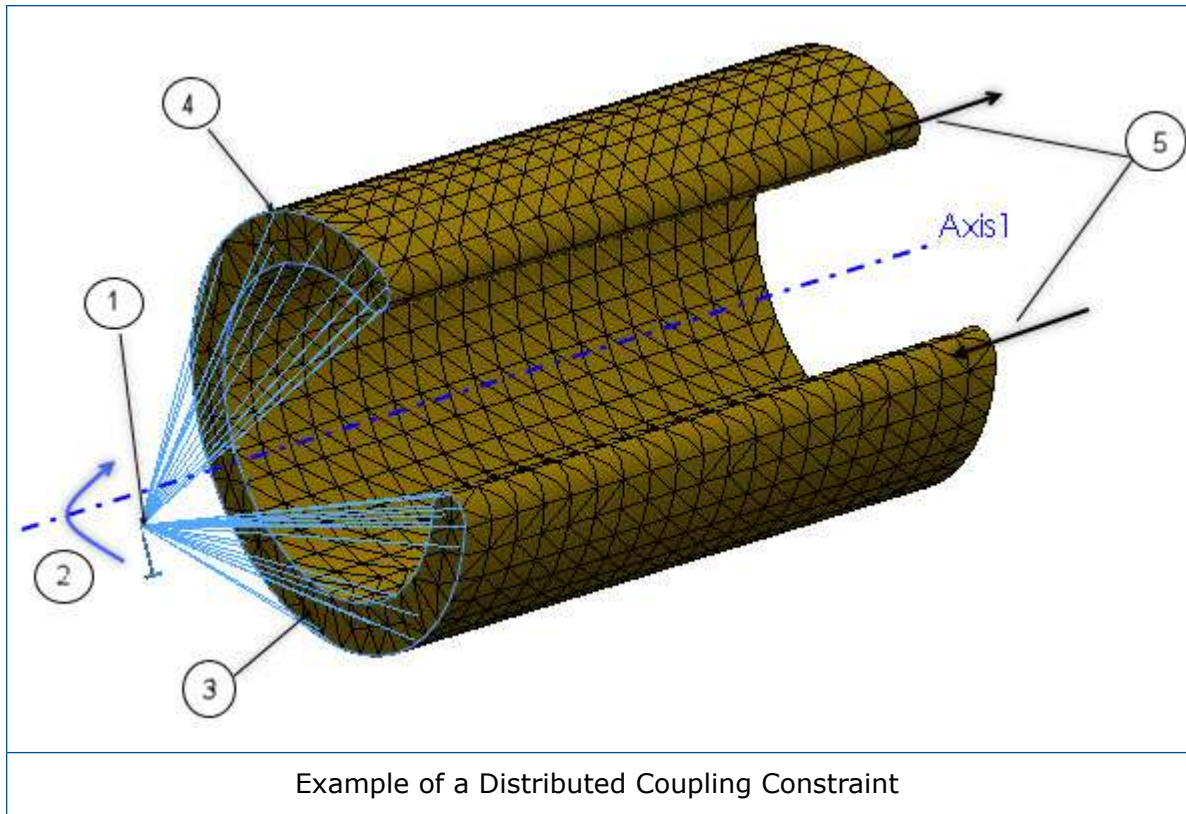

1	Reference node
2	Prescribed rotation
3	Face that defines the coupling nodes
4	Coupling nodes
5	Warping (out of plane deformation) permitted by the distributed coupling constraint

Forces and moments at the reference node are distributed either as a coupling node-force distribution only (default) or as a coupling node-force and moment distribution. This constraint distributes loads such that the resultants of the forces (and moments) at the coupling nodes are equivalent to the forces and moments at the reference node.

For cases of more than a few coupling nodes, the distribution of remote forces/moments and mass is not determined by equilibrium alone, and distributing weight factors scale the distribution. These weighting factors are available when **Connection Type** is **Distributed**:

- Default (constant)** Uniform weight distribution
- Linear** Weight factors decrease linearly with distance from the reference node.
- Quadratic** Weight factors decrease with distance from the reference node following a quadratic polynomial formulation.

**Cubic**

Weight factors decrease with distance from the reference node following a cubic polynomial formulation.

When **Connection Type** is **Rigid**, the coupling nodes do not move relative to each other. Rigid bars connect the attachment point to the coupling nodes, and high stresses can develop as a result. The faces where remote loads or displacements are applied behave like rigid bodies.

The remote load and mass combinations supported for the **Distributed** and **Rigid** connections are listed below (Linear static and Nonlinear static studies).

Remote Load Combinations	Distributed Connection	Rigid Connection
Force and Moment	Supported	Supported
Translation and Rotation	Supported	Supported
Force, Moment, Translation, and Rotation	Supported	Not supported
Force, Moment, and Mass	Supported	Supported
Translation, Rotation, and Mass	Supported	Not supported
Force, Moment, Translation, Rotation, and Mass	Supported	Not supported

For Mass, you need to define Gravity (and perhaps Centrifugal load).

## Pin Connector

The improved pin connector is extended to nonlinear static and nonlinear dynamic studies. You can define a pin connector through more than two cylindrical surfaces in one definition.

You can define a single pin connector attached to multiple coaxial cylindrical faces (maximum ten).

In the Connector-Pin PropertyManager, for **Cylindrical Faces/Edges** , select all coaxial cylindrical faces (or edges) that are attached to the pin (maximum of ten). The selected cylindrical faces or circular edges can belong to one body or to several bodies.

For example, for the two models below, you can define two pins (one for each model) to connect the two rotating parts and the six cylinders of a hinged plate. You can then run a nonlinear static or nonlinear dynamic study.

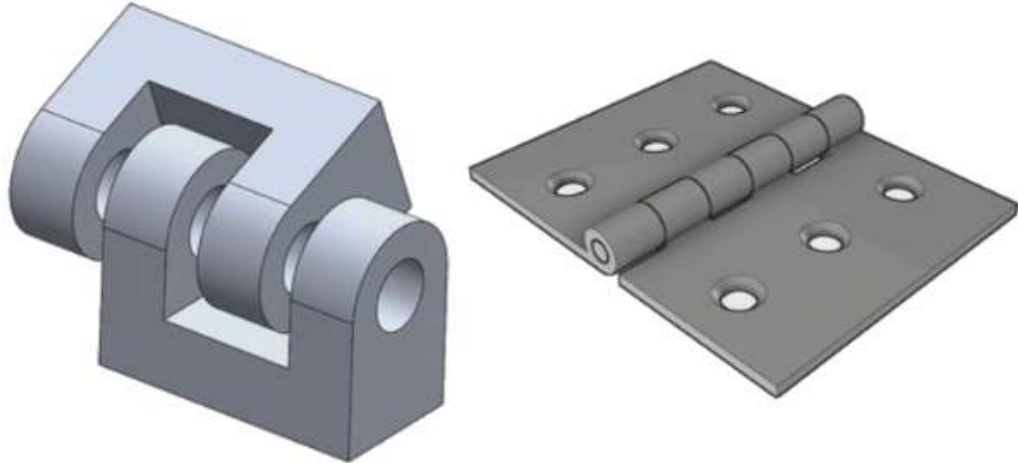

The solver calculates the pin connector forces at two pin joints per pin segment (a pin segment attaches to two cylindrical faces.) The safety factor for each pin connector is calculated based on the least FOS at the pin joints for the selected pin connector. The total axial and rotational stiffness you define for a pin connector is distributed according to each pin segment's geometric characteristics such as: cross sectional area, length, and polar moment of inertia.

For example, for a single pin definition connecting four cylinders of a hinged plate, the solver calculates the pin forces at four pin joints. Each pin joint is located at the centroid of each cylindrical face attached to the pin.

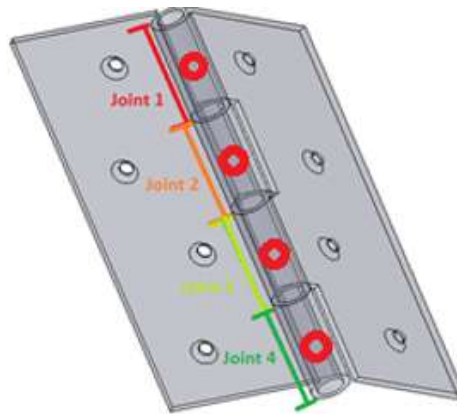

When viewing pin connector results, in the Result Force PropertyManager, click a table cell under **Connector Force** to highlight the location of the selected pin joint. A callout lists the pin forces at the selected joint. The directions of the pin resultant forces with respect to the pin's local coordinate system are also displayed: shear force resultant, axial force resultant, bending moment resultant, and torque resultant.

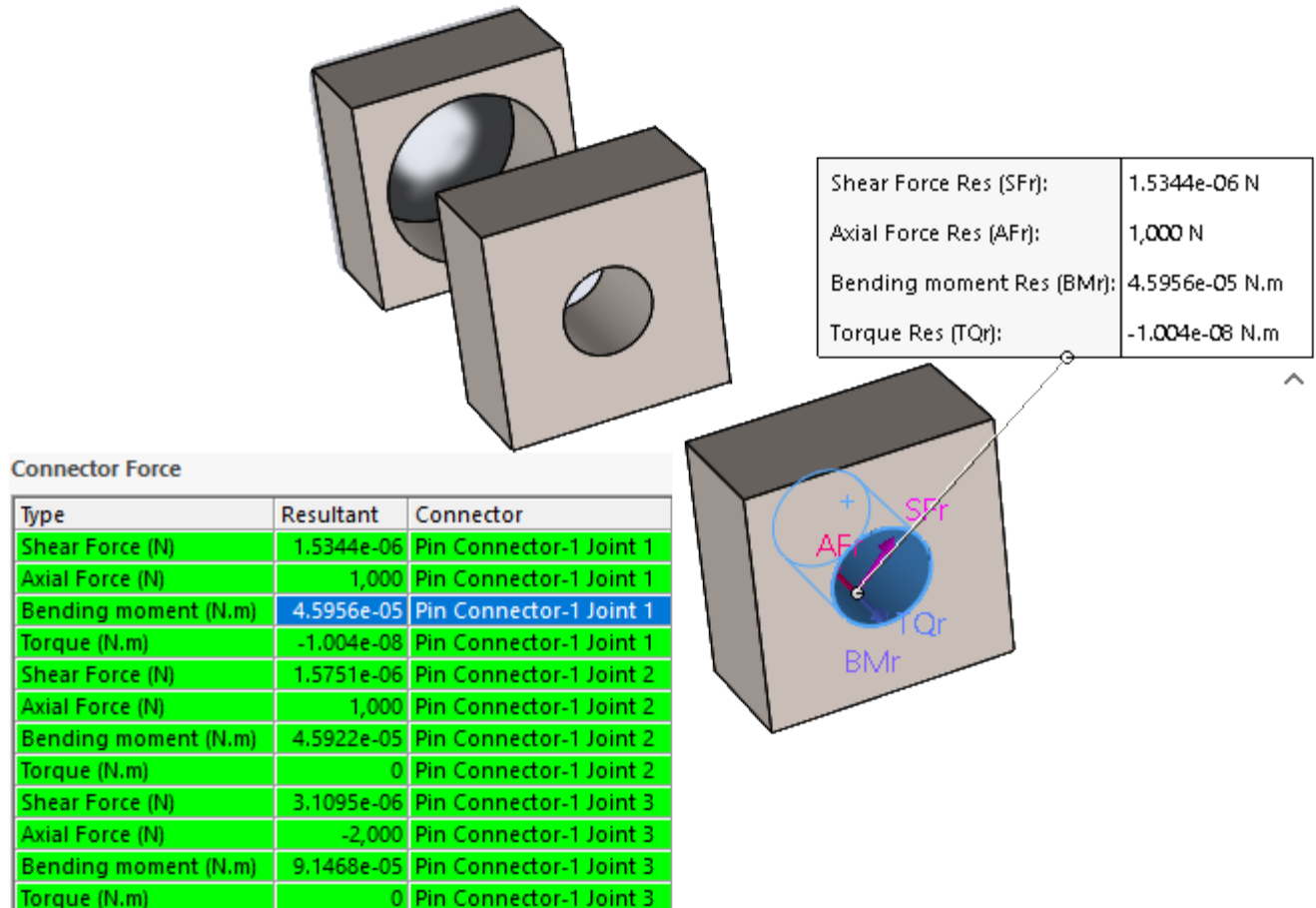

Click **List X,Y,Z components** to list the X, Y, and Z components of the pin forces with respect to the global coordinate system.

## Simulation Performance Improvements

The latest Intel<sup>®</sup> Parallel Studio XE 2018 Cluster edition replaces the existing Intel Fortran compiler, the Intel Math Kernel Library (MKL), and Intel MPI libraries used by the solvers.

The latest Intel 2018 Fortran compiler is used for part of the code that prepares data for the FFEPlus, Direct Sparse, and Intel Direct Sparse solvers, and computes stresses and strains. The Direct Sparse and the Intel Direct Sparse solvers are using the latest Intel MKL. Improvements in overall stability are expected as part of this upgrade.

The Intel Direct Sparse solver is reconfigured for optimized performance for Linear static studies with multiple load cases. Improvement in solution time is observed for up to 25 load cases.

These improvements apply to the optimized solver performance for linear static studies with multiple load cases:

- Only the Intel Direct Sparse solver (IDS) is configured for highly optimized performance. If you select the Direct Sparse or the Large Problem Direct Sparse solvers, the software switches internally to the IDS solver.

- This improves solver performance for Pressure, Force, and Torque load types. All other load types, connectors, and non-zero prescribed displacements should be exactly the same in all load cases to observe performance benefit. Load cases in the Load Case Manager are grouped together internally in such a way that load cases with similar features (such as mentioned above) are run together with the optimized performance scheme. Load cases with dissimilar features are run without any such optimization.
- The optimized solver performance is not activated when no-penetration contact or virtual wall contact are present in any load case, and also in a case of a distributed beam load, which varies across load cases.
- For a typical linear static study solved by the IDS equation solver, the most time-consuming part of the solution is the factorization of the global stiffness matrix, which consumes the majority of the total solution. In the optimized performance scheme, this factorization is done only once as the stiffness matrix is exactly the same for every load case. During the non-optimized performance scheme, the same factorization is repeated for the solution of each load case.

## Stress Averaging at Mid-side Nodes

An improved stress averaging method for the mid-side nodes is available for models with high-quality solid meshes.

In the **Default Options** > **Results** dialog box, under **Advanced Options**, select **Average stresses at mid-nodes (high-quality solid mesh only)**.

For a high-quality solid element, the stresses at the mid-side nodes are calculated by averaging the stress values at the associated corner nodes. This stress averaging method improves the calculation of stresses at mid-side nodes for tetrahedral elements with high aspect ratios. An example of the stress averaging is shown.

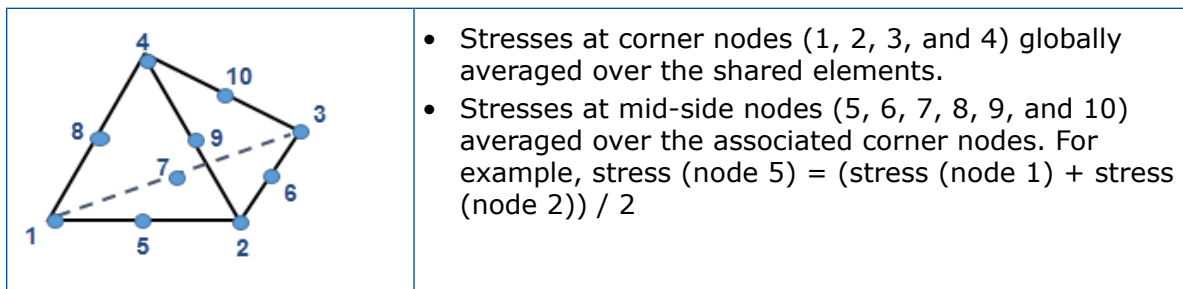

The improved stress-averaging method at mid-side nodes is available for all stress-based results across all studies, except for Linear Dynamic studies.

# Topology Study

Topology Study enhancements include: addition of stress (factor of safety) and frequency values as design constraints, export of an optimized shape as a mesh body, and an option to save intermediate results.

## Topology Constraints

You can define stress (factor of safety) and frequency values as design constraints for a Topology study.

For example, run a Topology study to find the optimal shape of a model with the largest stiffness for a 50% weight reduction and a maximum permissible stress condition. A stress constraint enforces the condition that a model after optimization cannot experience stresses larger than a percentage factor of the material's yield strength.

To specify a stress constraint, in the Goals and Constraints PropertyManager, select **Stress/Factor of Safety Constraint**. For **Type**, select either **Stress Constraint**, or **Factor of Safety Constraint**.

<b>Stress Constraint</b>	<p><b>Specified value</b> Enter the maximum permissible von Mises stress value for the optimized geometry.</p> <p><b>Specified factor</b> Enter the maximum permissible von Mises stress value as a percentage of the material's yield strength.</p>
<b>Factor of Safety Constraint</b>	<p>Enter the minimum acceptable factor of safety for the optimized geometry. The maximum permissible von Mises stress is calculated from the material's yield strength divided by the user-defined factor of safety. The maximum von Mises stress is the default FOS criterion used in this case.</p>

To specify a frequency constraint, in the Goals and Constraints PropertyManager, select **Frequency Constraint**. Enter a lower or upper, frequency limit, or range of permissible frequencies for the selected mode shapes.

Run a frequency study with the original model (maximum design space), before you run a topology study with frequency constraints, to evaluate the range of permissible natural frequencies.

Select **Mode tracking** to instruct the optimization solver to track the order of the selected mode shapes derived from the original geometry (throughout the optimization iterations) when enforcing frequency constraints.

When **Mode tracking** is cleared, the solver tracks the current order of mode shapes as derived for each optimization iteration. For example, it is possible for an optimization goal of a 50% mass reduction and a frequency constraint on the first mode shape. The first mode shape of the original geometry becomes the second or third mode shape of the optimized geometry.



For example, you add a frequency constraint on a distinct mode shape of a plate (the first mode in the original plate geometry). As the model shape changes during iterations, this mode may move down in the frequency list. By selecting **Mode tracking**, the solver keeps track of the same mode as it moves positions in the list of frequencies, and enforces the constraint on the same mode shape. When you clear **Mode tracking**, another mode shape replaces the original first mode in the course of iterations. The solver then applies the frequency constraint on this new mode that replaces the old mode.

For a Topology study with a specified frequency constraint only:

- Applied loads or prescribed displacements (including remote loads, translations, and rotations) are not considered in the calculation of the resonant frequencies.
- In the Remote Load/Mass PropertyManager, select **Connection Type > Rigid** to apply a remote mass. Any remote mass you apply with option **Connection Type > Distributed** is ignored by the solver.

## Export to Mesh Body

After you run a Topology Study, you can export the optimized shape (as shown in a **Material Mass** plot with smoothed mesh) to a mesh BREP body.

In the Export Smoothed Mesh PropertyManager, under **Advanced Export**, select **Solid body** or **Surface body**. Click **Create mesh bodies bounded by single faces**.

The mesh bodies (also known as mesh boundary representation or mesh BREP bodies) are made up of mesh facets (triangles). For solid bodies, the mesh facets form a closed boundary surface (also known as watertight mesh). For surface bodies, the mesh forms an open surface BREP.

Click **Group facets into faces** to collect the mesh facets into selectable faces. These mesh faces are defined as a collection of facets and do not have a parametric representation, so you cannot modify their dimensions.

You can save a mesh body in the current configuration (saved as imported body in the FeatureManager® design tree), in a new configuration, or in a new SOLIDWORKS part file (\*.sldprt).

The mesh BREP body is independent of the mesh representing the finite element model of the geometry in Simulation.

## Save Intermediate Topology Results

You can stop the analysis of a topology study before the final iteration completes and view intermediate results.

In a Topology study's progress dialog box, click **Stop and Save Results** before the solver completes the final iteration of the optimization.

The SOLIDWORKS Simulation software saves the results of the last running iteration. A warning message alerts you that the results may not be valid because the solver stopped before it reached convergence. You can view intermediate optimization results in a **Material Mass** Plot.

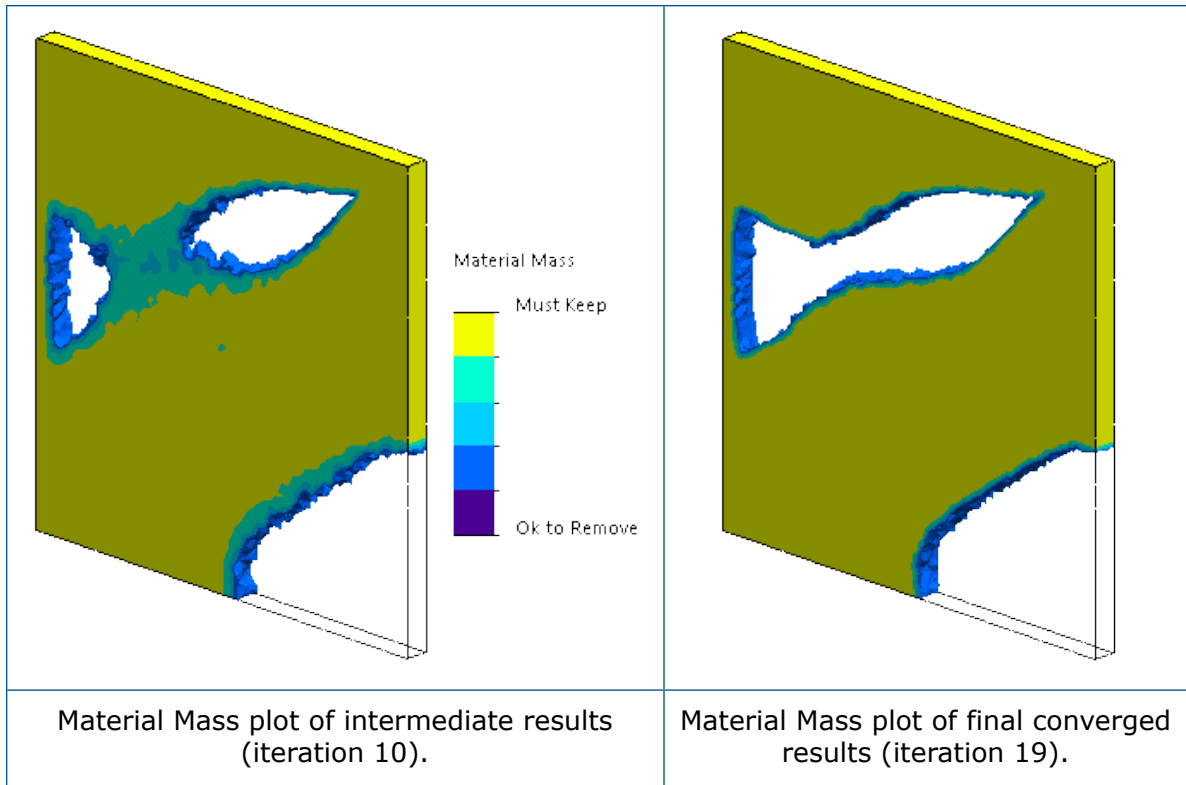

# 28

## Sketching

---

This chapter includes the following topics:



- **Editing Generic Splines**
- **Generic Spline PropertyManager**
- **Geodesic Entities**
- **Pen Tool Sketching Enhancements**
- **Projected Curve Enhancements**
- **Slicing Tool**
- **Trim Entities Enhancements**

### Editing Generic Splines



When you apply **Convert Entities**, **Offset Entities**, or **Intersection Curve** on a spline, the result is a **Generic Spline**. Generic splines replace splines.

Previously, it was difficult to control the shape of the spline. It is much easier to control the shape of the generic splines with the help of options in the Generic Spline PropertyManager.

#### To edit Generic Splines:

1. Open `system_dir:\Users\Public\Public Documents\SOLIDWORKS\SOLIDWORKS 2018\samples\whatsnew\sketching\SplinePart.sldprt`.
2. Click **Sketch > Convert Entities** .
3. Click the spline in `Sketch1`.
4. In the Convert Entities PropertyManager, click .
5. In the Generic Spline PropertyManager, in **Existing Relations**, right-click **On Edge 0** and click **Delete**.

6. Edit the generic spline with the following alternatives:



Option	Description
<b>Right-click the generic spline and click Show Control Polygon.</b>	Use the control polygon to shape the curve.
<b>Right-click the generic spline and click Convert to spline  or Convert to Style Spline .</b>	
<b>In the Generic Spline PropertyManager, under Parameters, click Rational.</b>	The <b>Control Vertex Weight</b> option is selected to let you adjust the curve shape.

7. Click .



## Generic Spline PropertyManager

The Generic Spline PropertyManager controls the geometry of the generic spline.

To open the Generic Spline PropertyManager:

1. Apply the **Convert Entities** , **Offset Entities** , or the **Intersect Curve**  tools on a spline by creating a reference plane.
2. Click the resultant spline.

### Existing Relations

	<b>Relations</b>	Displays relations inferred automatically during sketching or created manually with <b>Add Relations</b> .
	<b>Information</b>	Displays the status of the selected sketch entity ( <b>Fully Defined</b> or <b>Under Defined</b> ).

### Add Relations

<b>Fix</b>	Adds relations to the selected entity. The list includes only relations that are relevant for the selected entity.
------------	--

### Options

<b>For construction</b>	Converts the entities to construction geometry.
-------------------------	---

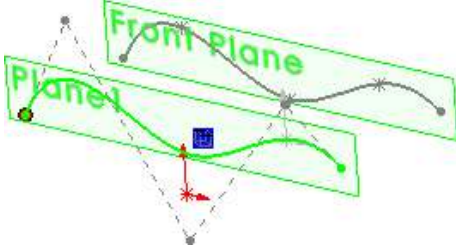
<b>Show curvature</b>	Adjusts the style spline curvature.
<b>Show Control Polygon</b>	Displays control polygons on the spline.
	
<b>Control Vertices</b>	Displays the total number of control vertices on the spline when you select <b>Show Control Polygon</b> .

## Parameters

<b>Non-rational Spline</b>	Creates nonrational splines on which you cannot control the vertices.
<b>Rational Spline</b>	Creates rational splines that you can control using the <b>Control Vertex Weight</b> option.
<b>Spline Point Number</b>	Edits the selection of the spline control vertex when you enter a value or use the toggle button.
$\mathbb{R}$	<b>X Coordinate</b>
$\mathbb{R}$	<b>Y Coordinate</b>

**Control Vertex Weight**

(Rational splines only) Shapes the spline by increasing or decreasing the weight of the control vertex.

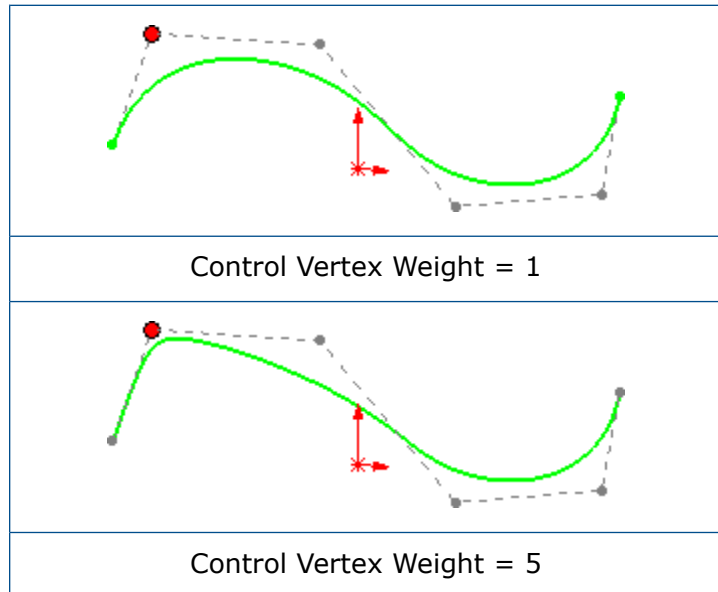

## Geodesic Entities

You can create geodesic 3D sketch offsets entities with the **Offset on Surface** tool.

Click **Offset on Surface** (Sketch toolbar) or **Tools > Sketch Tools > Offset on Surface** to open the Offset on Surface PropertyManager.

Previously, you were able to create only Euclidean offsets on surfaces.

The Offset on Surface PropertyManager has the following offset options:

<b>Geodesic offset</b>	Creates an offset distance that is the shortest possible distance between the selected edge and the resultant offset entity, taking the support curvature into account.
<b>Euclidean offset</b>	Creates a linear offset distance between the selected edge and the offset entity that does not include the curvature of surface.

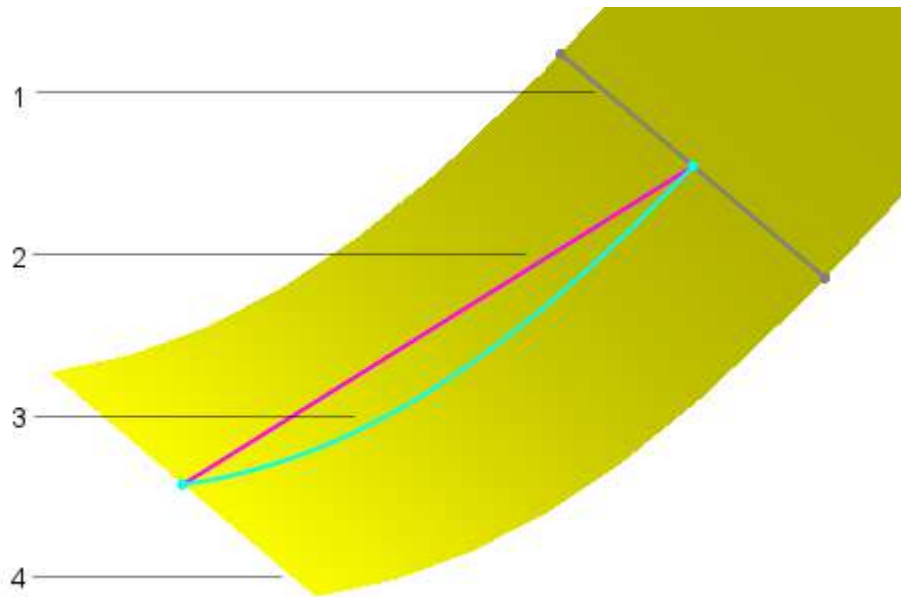



1	Offset sketch entity
2	Euclidean offset distance (measured as a linear distance)
3	Geodesic offset distance (measured along the surface)
4	Selected edge for offset



## Pen Tool Sketching Enhancements

You can use the **Pen**  tool to create splines, slots, ellipses, and dimensions.

The **Pen** tool is available on touch-enabled devices.

Sketch Ink CommandManager enhancements:

	<b>Convert to Ellipse</b>	Converts ink strokes into slot sketch entities when you sketch ellipses or slots. Click <b>Convert to Ellipse</b> on the context toolbar to toggle the shape from a slot to an ellipse.
	<b>Convert to composite shape</b>	Approximates ink strokes as lines and arcs.
	<b>Convert to spline</b>	Converts the lines and arcs of ink strokes into splines.

	<b>Ruler and Protractor</b>	Helps you create straight lines. When you sketch strokes close to the straight edge, they snap to the edge of the ruler. You can also access these tools from the Sketch Ink flyout menu.
	<b>Select</b> tool	Click the button on the barrel of the pen to toggle between <b>Pen</b> and <b>Select</b> modes. This helps you quickly drag and make selections.
Dimensions	Write dimensions with the <b>Pen</b> tool near entities and the application recognizes your handwriting as numbers that are applied to the entities as dimensions. To dimension a previously sketched line, select it and write the dimension.	

## Projected Curve Enhancements

You can create multiple closed or open contour projected curves in a single sketch. You can also use 3D sketches as input for the **Projected Curve** tool.

Previously, you had to create a separate sketch for each entity and then use the **Projected Curve** tool.

The **Bi-directional** option in the Projected Curve PropertyManager projects sketches in two opposite directions. You can also set a custom direction for projected curves, using a planar or linear reference such as an edge, sketch, plane, or a face.

The **Projected Curve** tool does not support projections of intersecting curves.

## Sketch on Sketch PropertyManager Enhancements

You can project sketches bidirectionally in the Sketch on Sketch PropertyManager.

## Sketch on Faces Projections

You can input the direction of the projected curve as a plane, edge, sketch, or a face, with the **Direction of Projection** option in the Projected Curve PropertyManager.

When using the **Projected Curve** tool for the **Sketch on faces** option, for **Direction of Projection**, you must select one of the following:

- Axis
- Linear sketch entity
- Linear edge
- Plane
- Planar face



# Slicing Tool

You can use the **Slicing** tool to create 2D sketch sections that are at the intersection of the source geometry and a reference plane.



The **Slicing**  tool creates 2D sketches and sketch planes at the intersection of a reference plane and standard SOLIDWORKS BREP geometry, mesh BREP geometry, and graphics bodies. You can use the 2D sketches to create solid or surface geometry and for reverse engineering or to create references for features based on a sliced section of the model.

For more information, refer to *SOLIDWORKS Help > Parts and Features > Mesh BREP Bodies*.

To access this tool, click **Insert > Slicing**.

## Slicing Mesh BREP Bodies Using Planar Entities

### To slice mesh BREP bodies using planar entities:

1. Open `system_dir:\Users\Public\Public Documents\SOLIDWORKS\SOLIDWORKS 2019\samples\whatsnew\sketching\wing.sldprt`.
2. Save a copy of the part as `wing_mesh.sldprt` and open the copy.
3. In the FeatureManager® design tree, expand **Solid Bodies(1)**, right-click **Loft2**, and click **Convert to Mesh Body** .
4. In the PropertyManager, click  to convert the solid body to a mesh BREP body.

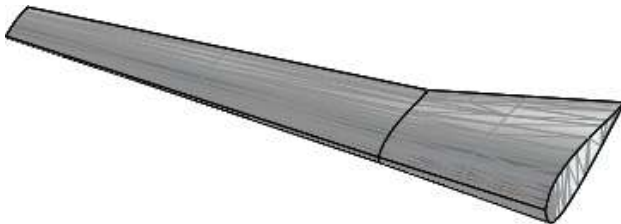

5. Click **Insert > Slicing** .
6. Select a facet in the center of the planar face as shown.

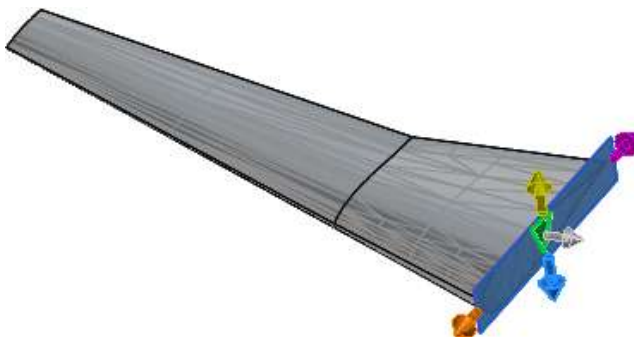

7. In the PropertyManager:
  - a) Click **Reverse Direction**  so the slices form toward the model.
  - b) For **Number of planes to create**, enter 8.
  - c) For **Offset**, enter 25.00in.

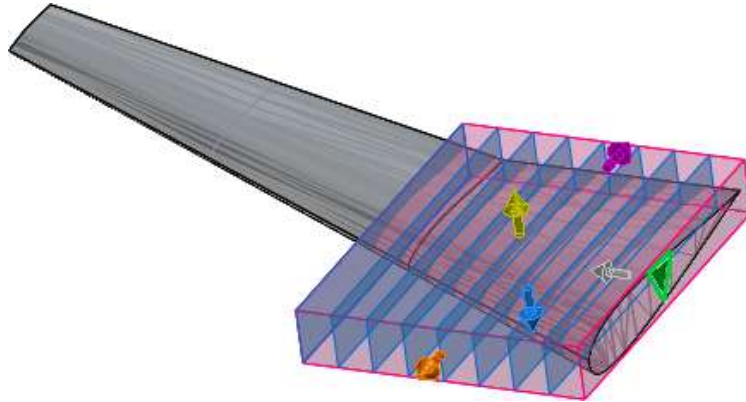

8. Click .

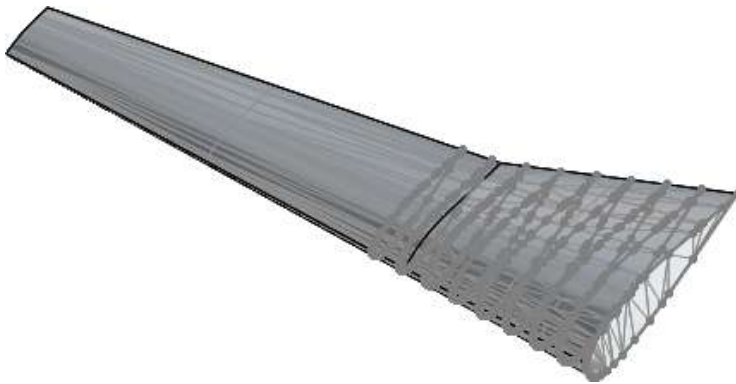

The software creates line segments wherever there are mesh intersections.

A **slice1** folder appears in the FeatureManager design tree that stores the slicing planes and sketches.

## Slicing PropertyManager

The Slicing PropertyManager creates 2D sketch sections.

### Slicing Planes

To access this tool, click **Insert** > **Slicing** . Select a planar entity or a combination of a linear entity and a point entity.

<b>Number of planes to create</b>	Sets the number of slicing planes to create. Planar entities produce a linear pattern of parallel planes, while the combination of a linear entity and a point produces a circular pattern of reference planes whose axis is the linear entity.
<b>Reverse Direction</b> 	Reverses the direction of the planes.
<b>Offset</b>	Sets the linear or angular spacing between planes.

## Options

<b>Add slicing planes and sketches to a folder</b>	Adds slicing planes and sketches to a folder in the FeatureManager design tree for an organized view. After you create sketches and reference planes with the <b>Slicing</b> tool, you can edit them individually only, not as a group.
<b>Preview slices (slower)</b>	Shows a preview of the slices in the graphics area.
<b>Slices to generate</b>	<p><b>Intersection</b> When selected:</p> <ul style="list-style-type: none"> <li>For classic BREP geometry, the slice is identical to what is generated with the <b>Intersection Curve</b> tool.</li> <li>For mesh BREP and graphics bodies, sketches generated by using the <b>Slicing</b> tool cannot be modified.</li> </ul> <p><b>Exact</b> Creates an exact intersection of the mesh BREP body and graphics body that results in a series of line segments called polyline. A polyline is a continuous line composed of one or more lines. Selected by default when you select a graphics mesh body or a BREP mesh body.</p> <p><b>Circle</b> Creates a circle. The diameter equals the average of the length and width of the rectangle that encloses all the sketch entities. The circle is located at the intersection of the source geometry and the slicing plane.</p> <p><b>Rectangle</b> Creates a rectangle that encloses all the sketch entities and is located at the intersection of the source geometry and the slicing plane.</p>

## Bounding Box

Each color arrow corresponds to the color of an extendable drag handle of the bounding box in the graphics area.

## Slicing Standard SOLIDWORKS BREP Bodies Using Linear and Point Entities

**To slice standard SOLIDWORKS BREP bodies using linear and point entities:**

1. Open `system_dir:\Users\Public\Public Documents\SOLIDWORKS\SOLIDWORKS 2019\samples\whatsnew\sketching\circular_part.sldprt`.
2. In the graphics area, **Ctrl** + select **Line1@3DSketch1** and the vertex as shown.

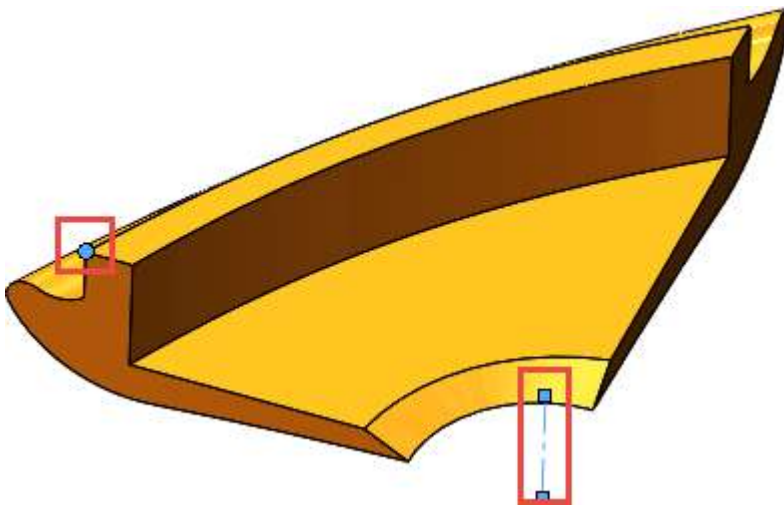

3. Click **Insert** > **Slicing** .

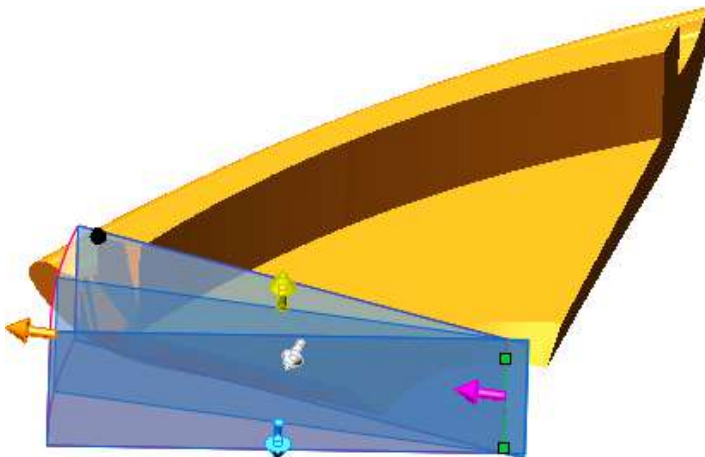

4. In the PropertyManager:
  - a) Click **Reverse Direction**  so the slices form toward the model.
  - b) For **Number of planes to create**, enter 10.

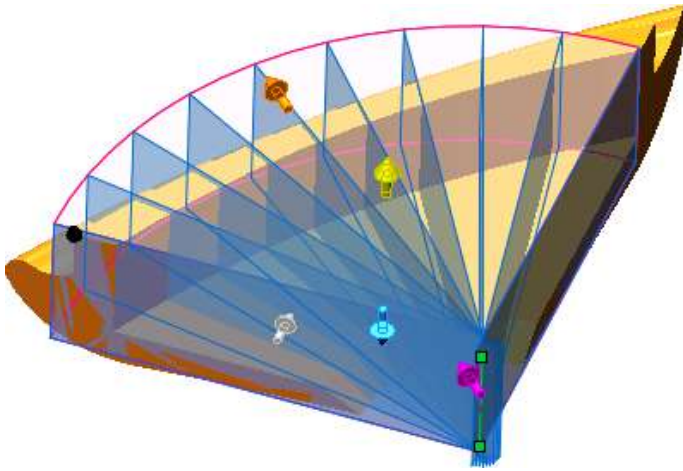

5. Drag the orange handle to enclose the whole model with the bounding box.

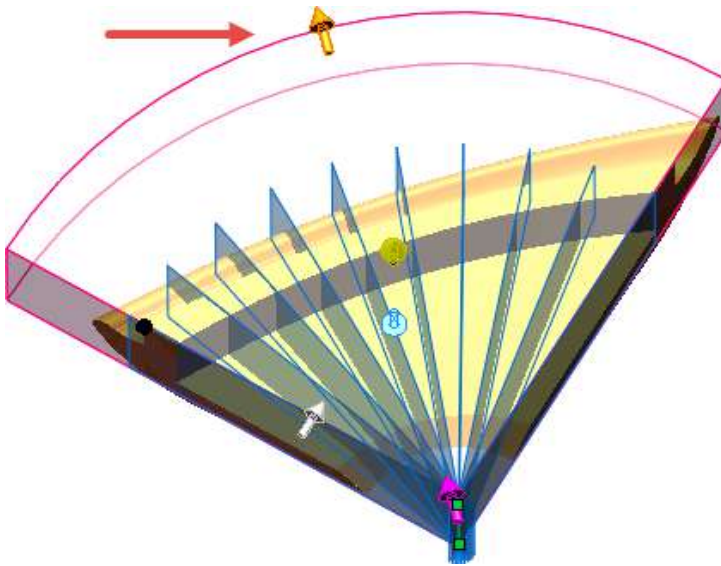

Use **Top** view to make sure that the bounding box covers the whole model.

- In the PropertyManager, select **Preview Slices (slower)** to preview each individual slice per slicing plane.

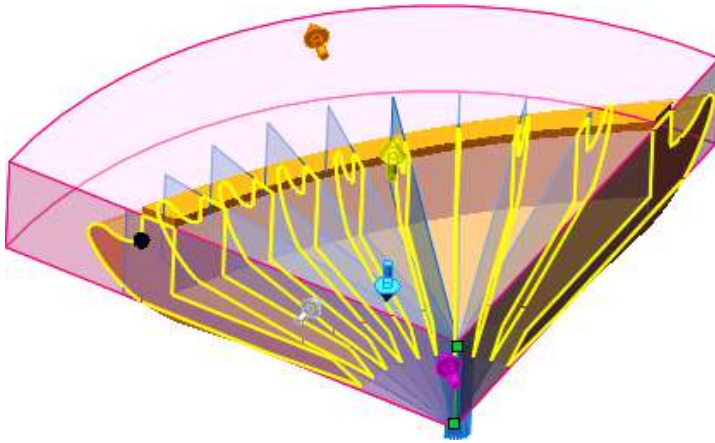

- Click .

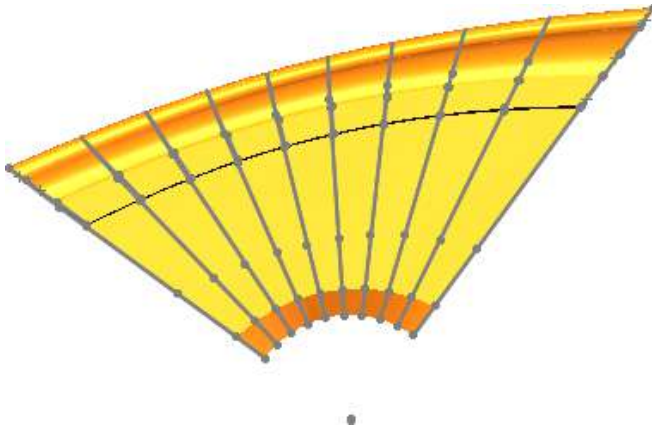

## Trim Entities Enhancements

You can convert trimmed entities into construction geometry or ignore construction geometry when trimming. This improves the handling of construction geometry for 2D and 3D sketches.

Previously, the **Trim Entities**  tool trimmed all entities, which often caused sketches to become under defined.

Click **Tools** > **Sketch Tools** > **Trim** to open the Trim Entities PropertyManager.

---

<b>Keep trimmed entities as construction geometry</b>	Converts the trimmed entities into construction geometry.
---	---

---

<b>Ignore trimming of construction geometry</b>	Leaves construction geometry unaffected when you trim entities.
---	---

---

These options maintain dimensional relations to the trimmed entities. They might maintain geometric relations, depending on the trimming conditions.

If you select both options, solid entities are converted to construction geometry and existing construction geometry is unaffected.

<p>Before trim</p>	
<p>Keep trimmed entities as construction geometry cleared</p>	
<p>Keep trimmed entities as construction geometry selected</p>	



# 29

## SOLIDWORKS Visualize

---

This chapter includes the following topics:

- **Automatic Data Recovery**
- **Customizing Keyboard Shortcuts**
- **Denoiser**
- **Importing Files**
- **Importing MDL Materials**
- **Model Tree Behavior**
- **Modifying Decal Mapping**
- **PBR Materials**
- **Physics Simulations**
- **Render Options**
- **Rendering Solid-Transparent Appearances**
- **Video Textures**

SOLIDWORKS Visualize is available as a separately purchased product that can be used with SOLIDWORKS Standard, SOLIDWORKS Professional, and SOLIDWORKS Premium or as a completely separate application.

### Automatic Data Recovery

If your session ends unexpectedly, you can recover automatically saved data the next time you start a session. You can specify the frequency and folder for saving auto-recovery data.

#### To specify automatic data recovery options:

1. Click **Tools > Options > Auto-Recover**.
2. In the dialog box, set options:

---

<b>Enable auto-recover</b>	Automatically saves unsaved data at the specified interval so you can recover it if your session terminates unexpectedly.
----------------------------	---

---

<b>Auto-recover interval (minutes)</b>	Specifies the number of minutes before an auto-recover file is created, and how often it is updated after that. The file is closed and deleted when you save your work.
--	---

---

---

**Auto-recover folder** Specifies the folder in which the auto-recover file is saved. The auto-recover folder must be a folder on your local system. You cannot use a network location or a mapped network drive.

---

## Customizing Keyboard Shortcuts

You can customize keyboard shortcuts for tools in SOLIDWORKS Visualize.

With the Hot Keys editor, you can create, manage, search, and filter keyboard shortcuts. You can back up and share the keyboard shortcut definitions across multiple installations.

Click **Tools** > **Hot Keys**.

## Denoiser

With the Denoiser, you can achieve significant reductions in render time for production-quality images.

The Denoiser is available in SOLIDWORKS Visualize 2018 Service Pack 3.0 and later.

The Denoiser uses a post-processing technique based on machine learning to filter out noise from unfinished and noisy images produced with **Fast** and **Accurate** render modes.

To achieve increased performance from using the Denoiser, you need to reduce the number of render passes. For example, if a scene routinely needs 500 passes without the Denoiser, specifying 50 passes when the Denoiser is on may achieve the same rendering quality. You may be able to achieve the same rendering quality with even fewer passes using the Denoiser depending on your goal for the image. Actual reductions in the number of passes, and therefore render time, depends on the computer's hardware and the scene rendered.

To use the Denoiser, you must have this hardware:

- NVIDIA® GPU (Kepler™ architecture or newer) with CUDA® 9.0 support
- At least 4 GB of video RAM

The following image shows typical results with Denoiser off (left) and on (right).







## Denoisier Example

In this example, you render a SOLIDWORKS Visualize project, first with the Denoisier turned off and then with it turned on. Then you examine the resulting images and compare the number of render passes, the render time, and the image quality.



## Creating the Baseline

First, you specify the options for offline rendering. Then, with the Denoiser turned off, you render the project to create a baseline .jpg image.

1. Open `system_dir:\Users\Public\Public Documents\SOLIDWORKS\SOLIDWORKS 2019\samples\whatsnew\visualize\Food Processor.svpj`.
2. Click **Output Tools**  (main toolbar).
3. In the dialog box, on the Render  tab, under **Output File:**
  - For **Image format**, select **JPEG (\*.jpg)**.
  - For **Output Mode**, select **Render**.
4. Under **Resolution:**
  - For **Size**, select **800 x 800 pixels**.
  - For **Resolution**, specify **96.00 pixels/in**.
5. Under **Render Settings:**
  - For **Renderer Selection**, select: **Accurate** .
  - For **Render Mode**, select **Quality**.
  - For **Render Passes**, specify **500**.
6. For **Render Device:**
  - Select **Hybrid**.
  - Select **Show Progress**.
7. Click **Start Render**.  
A Render tab opens.  
  
Click  to dismiss the message about closing Visualize if it appears.  
The offline rendering operation will take several minutes to finish.
8. When the render is finished, note the **Elapsed Time** reported at the top of the window.  
The baseline image `Food Processor.jpg` is automatically saved to your output folder.

## Using the Denoiser

Now render the same project using the Denoiser.

First, you need to initialize the Denoiser to make it available for use. When the Denoiser is initialized, it requires a certain amount of video RAM even if it is not currently being used. To use it for a particular rendering, you need to turn it on in a later step.

1. In the upper left of the window, click the Food Processor tab.
2. Click **Tools > Options**.
3. In the dialog box, click **3DViewport**.

4. Under **Denoiser**, select both options:

Option	Description
<b>Initialize Denoiser</b>	Makes the Denoiser available for use.
<b>Show Button in Main Toolbar</b>	Adds <b>Toggle Denoiser</b>  to the main toolbar, where you can click it to switch the Denoiser on and off.

5. Click **OK**.

6. Click **Toggle Denoiser**  (main toolbar) to turn on the Denoiser.

Denoiser is on for real-time rendering in the 3D Viewport.

Now you need to enable it for offline rendering. Also, to achieve increased performance from the Denoiser, you need to reduce the number of render passes.

7. Click **Output Tools**  (main toolbar).

8. In the dialog box, on the Render  tab, set these options:

- Under **Render Settings**, reduce the value for **Render Passes** to **50**.
- Select **Enable Denoiser**.

9. Click **Start Render**.

A new Render tab opens. The icon  in the heads-up display indicates that the Denoiser is on.

Click  to dismiss the message about closing Visualize if it appears.

10. When the render is complete, note the **Elapsed Time** reported at the top of the window.

The image rendered with the Denoiser on, `Food Processor 1.jpg`, is automatically saved to your output folder.

#### 11. Click the link to your output folder.

You can open both images of the food processor in your favorite image viewing application. You can zoom in and compare the amount of noise in various areas. For example, zoom to the area around the blade shaft:

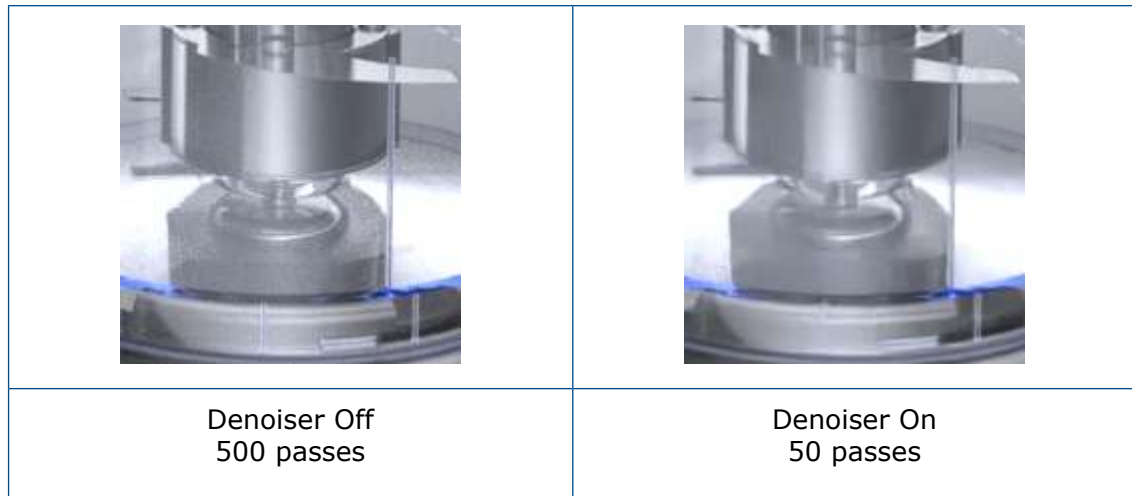

Using the Denoiser, you may be able to achieve the same rendering quality with even fewer passes, depending on your goal for the image.

Actual reductions in the number of passes, and therefore render time, depends on the computer's hardware and the scene rendered.

## Importing Files

### FBX Files

The .FBX importer is updated to version 2018.1.1.



### IFC (Industry Foundation Classes) Files

You can import IFC files into SOLIDWORKS Visualize. Click **File > Import** and browse to the file. In the **Files of type** list, you can select **Industry Foundation Classes (IFC) (\*.ifc;\*.ifczip)** to show only files of those types.

## Importing MDL Materials

You can import NVIDIA Material Definition Language (MDL) materials.

The material properties are read-only. You cannot create MDL materials in SOLIDWORKS Visualize.

In the Palette, on the Appearance  tab, click **Add**  > **Import Appearance** and select an MDL material.

## Model Tree Behavior

You can change the order of items in the tree. Drag models, parts, and groups and drop them in new positions in the tree.

You can drag parts into or out of a group.

You can move parts into a group. Right-click a part, click **Edit** > **Move Parts to New Group**, and select the name of an existing group.

## Modifying Decal Mapping

You can modify the mapping of any decal, whether imported or applied in SOLIDWORKS Visualize, to use **Cylindrical**, **Spherical**, and **Label (UV)** mapping modes.

1. Select a decal.
2. In the Palette, in the Appearance  tab, in the Mapping subtab, select a mapping mode:
  - **Cylindrical**
  - **Spherical**
  - **Label (UV)**

The mapping controls in the Palette and the manipulator in the viewport correspond to the mapping mode you select.

You can switch mapping modes, adjust how the decal image appears, and adjust the definition of the mapping projection.

## PBR Materials

You can create appearances using Physically Based Rendering (PBR) materials.

PBR materials natively support sets of PBR texture maps that use the Metallic/Roughness or the Specular/Glossiness workflow.

1. In the Palette, in the Appearance  tab, click **Add**  > **New Appearance**.
2. For **Appearance Type**, select **PBR Material**.
3. In the Texture subtab, select a texture map such as **Color**, **Metallic**, **Roughness**, or **Bump**.

# Physics Simulations

You can perform a simple rigid body simulation alongside a more complex vehicle simulation.

The system supports these scenarios:

- Driving a car alongside a predefined path
- Steering via the keyboard or a connected game controller

You can record any simulation as a key frame animation to easily replay or render it.

# Render Options

## Offline Render Options

In the Output Tools dialog box, for **Fast** render mode you can specify **Render Passes** or **Time Limit**.

## Real Time Render Options

You can control the maximum number of iterations (render passes) directly in the heads-up display. The values for **Fast** mode and **Accurate** mode are managed separately.

# Rendering Solid-Transparent Appearances

You can use **Refract Background** to obtain more plausible results when you render scenes that use a solid-transparent appearance and have a backplate or background color.

**Refract Background** is a project property. If you turn it on or off, the change applies only to the active project.

Typically, the refractive rays in a scene are computed from the HDR environment, whether it is visible or not. However, if the HDR environment is hidden by a backplate or background color, problems can occur when you render objects with solid-transparent appearances.

For example, this scene shows a glass with a solid-transparent appearance. Because the HDR environment is visible, the background and lighting come from the same source. The transparency is plausible.





If you render the same scene with a backplate or a background color, the HDR environment is not visible. If **Refract Background** is off, the transparency effect is broken because the color from the invisible HDR environment still passes through the transparent glass.

<p style="text-align: center;">Backplate <b>Refract Background off</b></p>	<p style="text-align: center;">Background color <b>Refract Background off</b></p>

If **Refract Background** is on, the software computes the refractive rays from the backplate or the background color. The reflections and illumination are derived from the HDR environment. The results are much more plausible.

	
<p style="text-align: center;">Backplate <b>Refract Background</b> on</p>	<p style="text-align: center;">Background color <b>Refract Background</b> on</p>

### To turn **Refract Background** on or off:

1. In the Palette, on the Scenes  tab, select an environment in the tree.
2. On the General subtab, select or clear **Refract Background**.
  - If selected (on), the software computes the refractive rays from the backplate or the background color.
  - If cleared (off), the software computes the refractive rays from the HDR environment.

The state of the **Refract Background** property is changed only within the active project.

**Refract Background** has no effect if the HDR environment is visible.

### Limitations:

- If you place an object that refracts the complete environment, such as a sphere, in front of a backplate, the 2D information from the backplate is insufficient to compute all refractive rays. Instead, the software uses clamping (repetition of the texture's edge color values) to fill in the missing information.





- In **Accurate** render mode, **Refract Background** works only for appearances with **Roughness** = 0.00.

# Video Textures

You can use videos and image sequences as decals.

You can control and synchronize the playback of the decals by using the animations that they automatically create in the timeline.

1. In the Palette, in the Appearance  tab, click **Add**  > **Decal**.
2. Do one of the following:
  - Click **Video** and select a supported video file.
  - Click **Image Sequence** and select a series of images.

# 30

## Weldments

---

This chapter includes the following topics:

- **Configuring Cut Lists**
- **Structure System**

### Configuring Cut Lists

In the Cut-list dialog box, you can configure cut lists by clicking the **Configuration** list in the upper left corner of the **Cut-list Summary** tab.

You can also apply a configuration to a cut-list property. In the **Cut-list Summary** tab, click **Configuration** next to the **Value/Text Expression** and select one of the following:

- **This Configuration**
- **All Configurations**
- **Specify Configurations**

The evaluated value updates.

If a property links to a parent configuration, clear the link before assigning a configuration to the value/text expression.

### Structure System

The structure system feature is an advanced weldments environment that lets you create and modify structural members of different profiles in one feature. The workflow makes it easier to create complex structure systems with flexible corner management and trimming.

The structure system comprises primary and secondary structural members. You build primary members on a grid you create using 2D and 3D sketch segments, points, edges, reference planes, and surfaces. Secondary members each run between two primary members. You define secondary members by selecting a support plane and two primary members, or by clicking two primary members.

When you finish defining the structural members, the software opens the Corner Management PropertyManager so you can fine-tune the corner treatments. Corners update automatically when you make changes to the structure system or member profiles.

These tools make up the structure system feature:

<b>Create Structure System</b>	Activates the Structure System mode. (Similar to clicking Sketch to enter Sketch mode.)
<b>Primary Structural Member</b>	Adds members defined by sketch entities, points, reference planes, and surfaces.
<b>Secondary Structural Member</b>	Adds members between two primary members.
<b>Corner Management</b>	Groups corners into simple, two member, and complex corner types, and applies trim treatments.
<b>Predefine pierce point in profile</b>	Defines a pierce point in structural member sketch.
<b>Align Member</b>	Zooms to the profile of the structural member and shifts the profile to align the pierce points with the structural member sketch segment.

## Entering Structure System Mode

Structure System mode is the design environment where you create an advanced welded structure system.

### To enter Structure System mode:

1. Open `system_dir:\Users\Public\Public Documents\SOLIDWORKS\SOLIDWORKS 2019\samples\whatsnew\parts\structure_system.sldprt`
2. Click **Insert > Structure System > Structure System** .



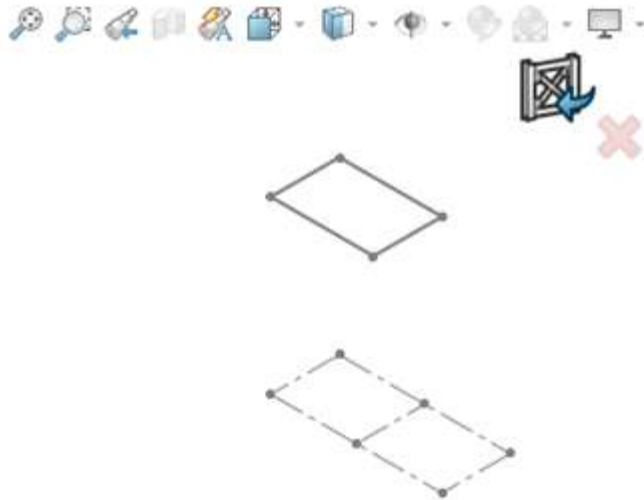

You can also enter Structure System mode from the Structure System tab in the CommandManager.

The Structure System mode icon appears in the Confirmation Corner of the graphics area.



## Primary Members



You can create primary members with these methods:

	<b>Path Segment</b>	Creates a member along a sketch entity. Select one or more sketch entities (similar to weldments). You can also select model edges for path segments.
	<b>Reference Plane</b>	Creates a member along the intersection of two or more planes.
	<b>Point and Length</b>	Creates a member originating at a point and extending for a specified length. Select one or more points and specify a length.
	<b>On Face</b>	Creates a member along the intersection of a face or surface, and a plane.

## Specifying the Profile

You can apply different profiles to members in a structure system.

### To specify the profile:

1. Click **Primary Member**  (Structure System CommandManager).
2. Click **Pin**  at the top of the PropertyManager.

- In the PropertyManager, on the Profile tab, set:

Option	Description
<b>Standard</b>	Iso
<b>Type</b>	Sb beam - Configured
<b>Size</b>	120 x 12

## Creating Primary Members Based on Points and Length

### To create primary members based on points and length:

- Expand the flyout FeatureManager® design tree in the graphics area.
- Click the Member tab and click **Point Length Member**  for **Primary Member Type**.
- In the graphics area, click each point at the corners of the **Template** sketch.

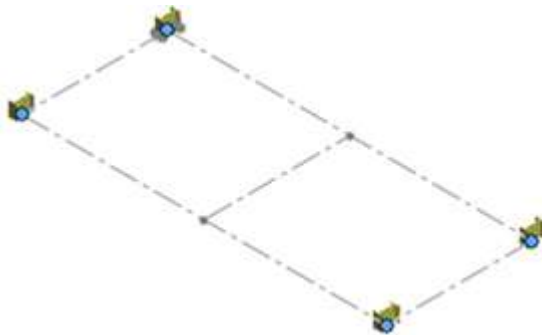

- Enter 2700mm for **Length** in the PropertyManager.
- Click .

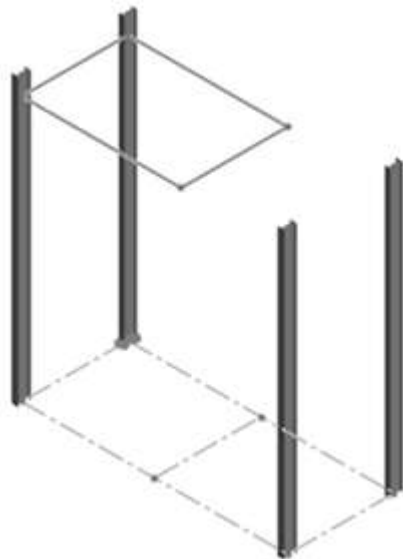

## Creating Primary Members from Path Segments

**To create primary members from path segments:**

1. Click **Path Segment Member**  for **Primary Member Type**.
2. In the graphics area, click the four line segments that make up the **Overhang** sketch.

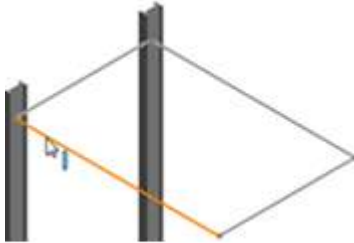

3. Click .



## Creating Primary Members from Reference Planes

**To create primary members from reference planes:**

1. Click **Ref Plane Member**  for **Primary Member Type**.



2. For **Reference Set**, select the following planes in the flyout FeatureManager design tree.

You can also display and select the planes in the graphics area by clicking **View > Hide/Show > Planes**.

- a) For **Start and End Plane**, click **Base** and **Third**.

These planes are parallel and define the length of the members.

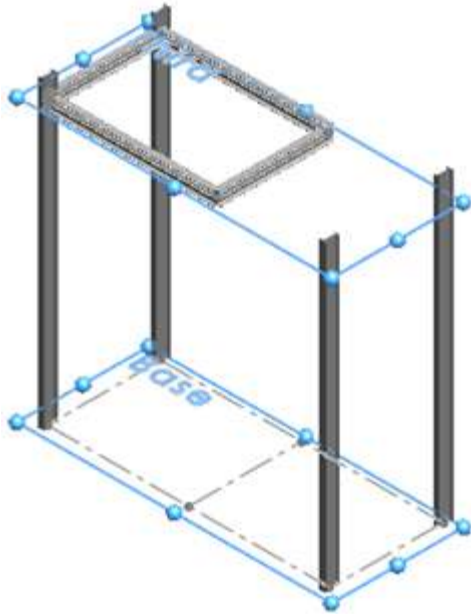

- b) For **Plane Set 1**, click **Right Plane**.

This plane is perpendicular and intersects with the **Start and End Plane**.

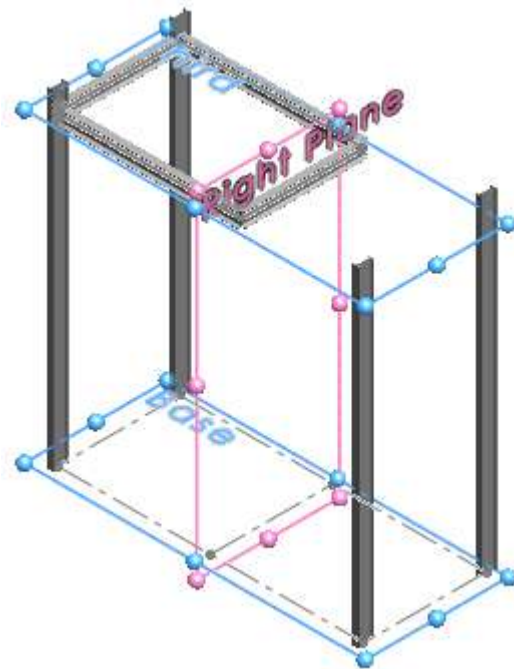

- c) For **Plane Set 2**, click **Front-1** and **Back**.

**Plane Set 2** intersects with **Plane Set 1**. They define the location of the two members that are in the middle of the structure.

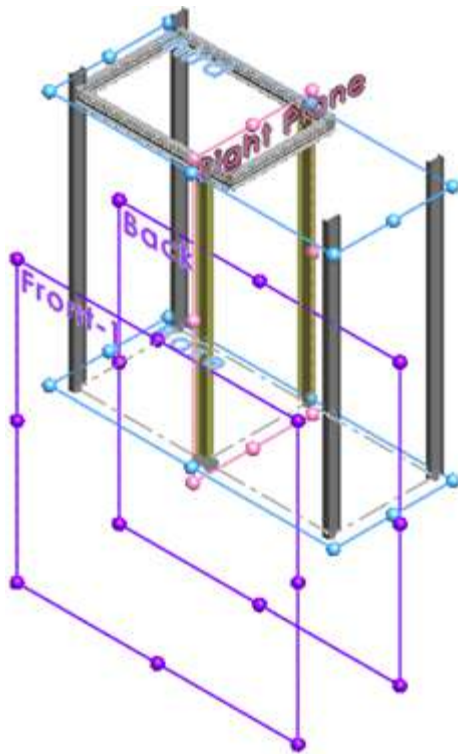

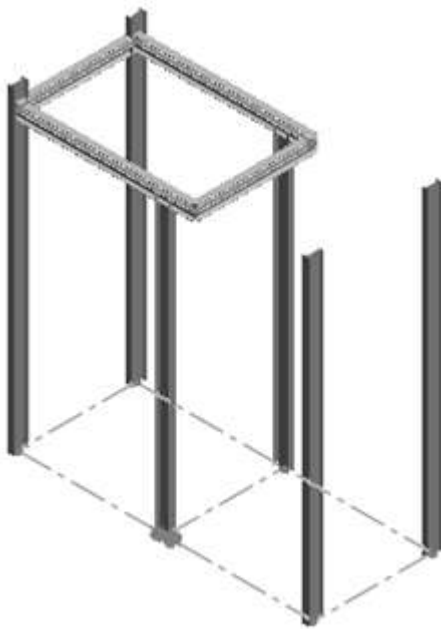

3. Unpin  the PropertyManager and click .

The primary members of the structural system are complete.





## Secondary Members

	<b>On Plane</b>	Creates a member on a plane between two primary members. Select a plane and two primary members.
	<b>Between Points</b>	Creates a member between the location you select on two primary members. Click the location for the endpoints of the new member. You can refine the locations by specifying a distance from the selected primary members.

## Creating Secondary Members from Reference Planes

**To create secondary members from reference planes:**

1. On the Structure System tab, click **Secondary Member** .
2. Click **Pin**  at the top of the PropertyManager.
3. Click **Support Plane Member**  for **Secondary Member Type**.
4. For **Support Plane**, select the **Second** plane in the flyout FeatureManager design tree.

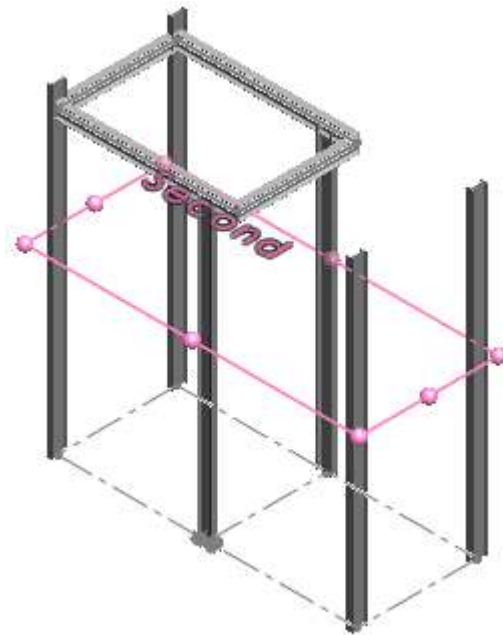

5. Click **Link**  and click in **Member Pairs**.  
**Link** creates a chain of member pairs. The endpoint of one member pair is used as the beginning of the next member pair in the chain.

6. In the graphics area, select the first two members under the **Overhang** as shown. The PropertyManager lists this member pair as **Member1, Member9**.

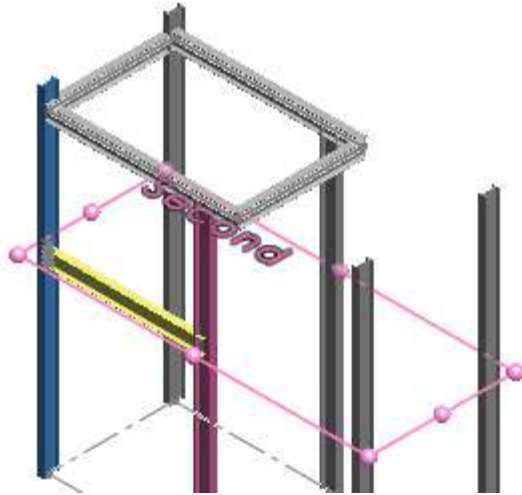

7. Select the remaining vertical members.

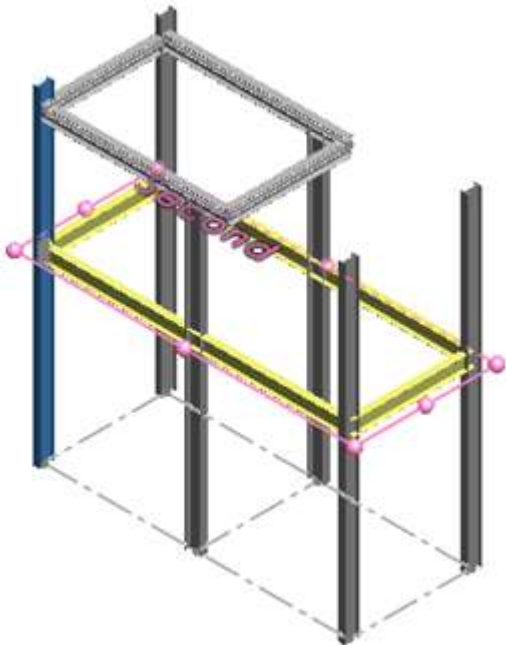

8. Right-click in **Member Pairs** and click **Delete** to remove **Member1, <Select>** from the following list:

- Member1, Member9
- Member9, Member4
- Member4, Member3
- Member3, Member10
- Member2, Member1
- Member1, <Select>

The members in the list may vary depending on the order that you select them.

9. In the PropertyManager, click **Support Plane**.

10. In the flyout FeatureManager design tree, click the **First** plane to add another level of secondary members.
11. Click .

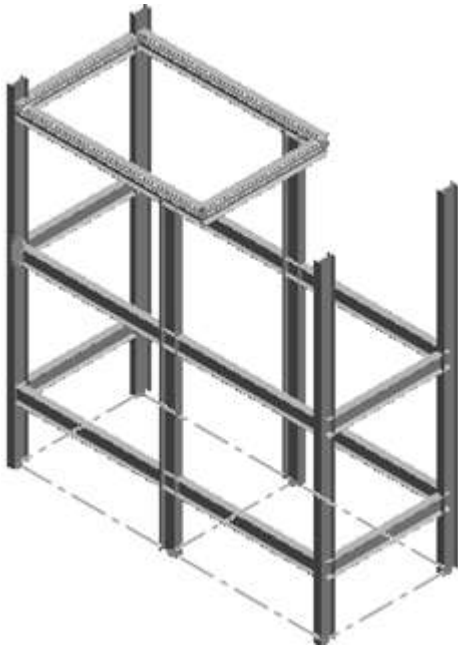



## Creating Secondary Members Between Points and Changing Profiles

**To create secondary members between points and change profiles:**

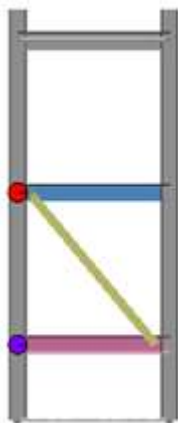
1. Click **Between Points Member**  for **Secondary Member Type**.
2. Change the orientation of the model by clicking **View (Heads-Up) > Left View** and select the secondary members shown.



3. Adjust the position of the new secondary member by clicking the **Up** and **Down** arrows for **Mem 1** and **Mem 2**.

4. Change the profile of the secondary member:
  - a) Click Profile tab.
  - b) For **Type**, select **rectangular tube - Configured**.
  - c) For **Size**, select **70 x 40 x 5**.
5. Change the orientation of the model by clicking **View (Heads-Up) > Isometric**.
6. Unpin  the PropertyManager and click .
7. Click the **Structure System** icon in the Confirmation Corner.

The Corner Management PropertyManager displays. Simple corners highlight in the model.

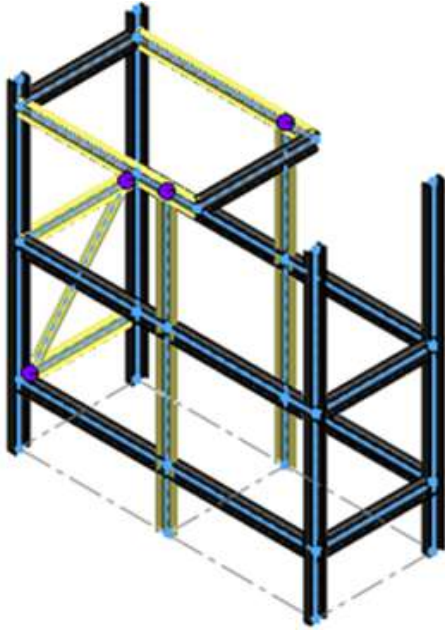

## Corner Management

When you create a structure system for the first time, the Corner Management PropertyManager opens automatically.

In the PropertyManager, corners are grouped according to the number of members that meet at a point and joint type. Corners are also color-coded to make them easier to identify in the graphics area.

Corner type	Description
Simple	The position where the ends of two members meet and the segments are collinear.
Two corner	The position where two members intersect.
Complex	The position where more than three members intersect.

Trim options let you modify and adjust joints between multiple structural members or between structural members. For models with two corners and complex corners, you can

assign a member as the trim tool. You can use it as a cutting tool to add or remove material from neighboring members.

## Editing Simple Corners

There are two methods for trimming:

- Body trim. Conforms the intersecting member to the shape of adjacent faces by adding or removing material.
- Planar trim. Cuts the intersecting member with a plane at first contact or full contact. First contact trims the member when it first comes into contact with adjoining faces. Full contact is where the member is trimmed flush with adjoining faces.

### To edit simple corners:

1. Change the orientation of the model by clicking **View (Heads-Up) > Left View**.
2. On the Simple tab of the PropertyManager, click **Simple2**.
3. Zoom to the intersection of the corner.

The secondary member is trimmed at first contact.

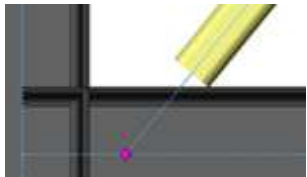

4. For **Planar Trim Options**, click **Full Contact** .
- The corner is trimmed flush against the adjacent face.



5. Click .



## Trimming Complex Corners

You assign a member as the trim tool. This member defines the tool body for all other members. You can use it as a cutting tool to add or remove material from neighboring members. The trim tool extends as needed and cannot be trimmed by any other member.

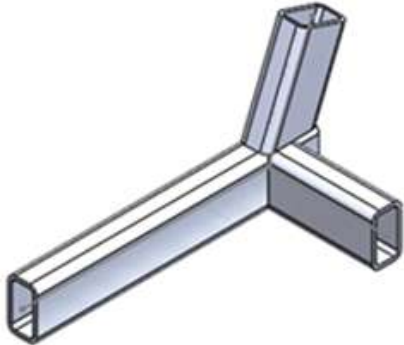

### To trim complex corners:

1. Open `system_dir:\Users\Public\Public Documents\SOLIDWORKS\SOLIDWORKS 2019\samples\whatsnew\parts\trim_complex_corner.sldprt`.

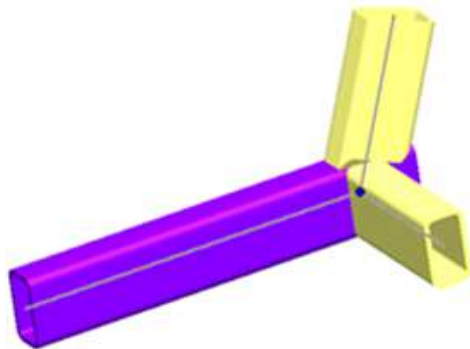

2. In the FeatureManager design tree, right-click **Corner Management** and click **Edit Feature** .
3. In the PropertyManager, under **Corner Treatment**:
  - a) Select **Trim Order = 1, Member 6** and click  to move it to **Trim Tool Member**.



- b) Select **Trim Order = 1, Member 5** and click  to move it to **Planar Trim**.
  - c) Click **Full Contact**  for **Planar Trim Type**.
4. Zoom to the intersection of the corners in the graphics area.



5. In the PropertyManager, select **Member4** and **Member5** to display the trim effect.

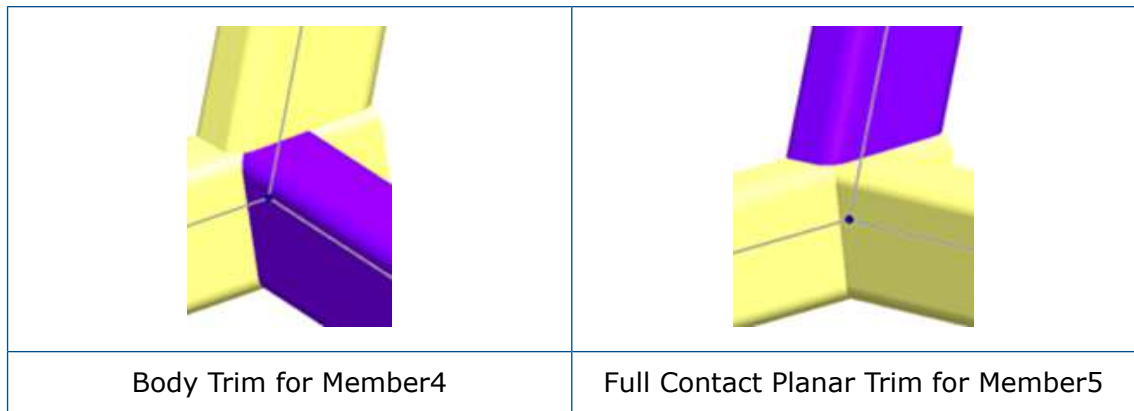

6. Click  .

[www.solidworks.com](http://www.solidworks.com)

**Dassault Systèmes SolidWorks Corp.**  
175 Wyman Street  
Waltham, MA 02451  
Phone: 1 800 693 9000  
Outside the US: +1 781 810 5011  
Email: [generalinfo@solidworks.com](mailto:generalinfo@solidworks.com)

**Europe Headquarters**  
Phone: +33 4 13 10 80 20  
Email: [infoeurope@solidworks.com](mailto:infoeurope@solidworks.com)

**Japan Headquarters**  
Phone: +81 3 6270 8700  
Email: [infojapan@solidworks.com](mailto:infojapan@solidworks.com)

**Asia/Pacific Headquarters**  
Phone: +65 6511 9188  
Email: [infoap@solidworks.com](mailto:infoap@solidworks.com)

**Latin America Headquarters**  
Phone: +55 11 3186 4150  
Email: [infoa@solidworks.com](mailto:infoa@solidworks.com)

---

## Our **3DEXPERIENCE**® platform powers our brand applications, serving 12 industries, and provides a rich portfolio of industry solution experiences.

Dassault Systèmes, the **3DEXPERIENCE**® Company, provides business and people with virtual universes to imagine sustainable innovations. Its world-leading solutions transform the way products are designed, produced, and supported. Dassault Systèmes' collaborative solutions foster social innovation, expanding possibilities for the virtual world to improve the real world. The group brings value to over 220,000 customers of all sizes in all industries in more than 140 countries. For more information, visit [www.3ds.com](http://www.3ds.com).



**3DEXPERIENCE**®

©2018 Dassault Systèmes. All rights reserved. **3DEXPERIENCE**®, the Compass icon, the 3D logo, CARTA, SOLIDWORKS, ENOVIA, DELMIA, SIMULIA, GEODIA, EXALEAD, 3D VIA, BIOVIA, NETVIBES, IPWE and 3DEXITE are commercial trademarks or registered trademarks of Dassault Systèmes, a French "société européenne" (Versailles Commercial Register # B.322.306.440), or its subsidiaries in the United States and/or other countries. All other trademarks are owned by their respective owners. Use of any Dassault Systèmes or its subsidiaries trademarks is subject to their express written approval.

 **DASSAULT SYSTEMES** | The **3DEXPERIENCE**® Company

**Americas**  
Dassault Systèmes  
175 Wyman Street  
Waltham, Massachusetts  
02451-1223  
USA

**Europe/Middle East/Africa**  
Dassault Systèmes  
10, rue Marcel Dassault  
CS 40501  
78946 Vélizy-Villacoublay Cedex  
France

**Asia-Pacific**  
Dassault Systèmes K.K.  
ThinkPark Tower  
2-1-1 Osaki, Shinagawa-ku,  
Tokyo 141-6020  
Japan